



RECOIL®

Price
List
2013



Proudly Distributed by:

suttontools
world class cutting tools

General Terms and Conditions

Full terms & conditions are available on request

PRICES:

Prices are based on purchases of standard package as indicated in the price list and catalogue. Orders received for quantities other than the multiples of our standard packages will be increased to the next highest standard pack multiple. All prices in this list are exclusive of GST.

FREIGHT:

Orders received before 3.00pm will generally be despatched the same day (subject to stock availability). Freight is prepaid on Alcoa Fastening Systems nominated carrier only on invoices over \$150.00 net value.

Freight charges/method as follows:-

Up to 3kg	Air bag or local carrier	\$12.00
3 kg +	Road freight	\$15.00

Where customer nominates a carrier other than Alcoa Fastening Systems carrier, all charges are to their account.

MINIMUM INVOICE:

No order can be processed if under \$50.00 net value. (Excluding freight and GST).

RETURNED GOODS / CREDIT POLICY:

- A. Written authorisation to return material, including an GRN (Goods Return Note) number must be obtained from Alcoa Fastening Systems Sales on 1300 363 049, prior to returning goods for credit. GOODS THAT DO NOT CARRY OUR AUTHORIZATION NUMBER WILL NOT BE ACCEPTED.

- B. Accompanying documentation must have the name of the person who authorised the return, the GRN number quoted and a contact name with their phone number from your company.
- C. Handling / Repackaging charge. A 15% handling charge for restocking goods in resaleable condition and a 50% charge for goods that need to be repackaged.
- D. Freight - any freight for returns must be prepaid except where prior written agreement has been obtained from Alcoa Fastening System Sales, in which case Alcoa Fastening Systems nominated carrier MUST be used.
- E. Credit for returned goods will be given on the basis of prices paid (as substantiated by accompanying invoice number).
- F. Credit on authorised returns is subject to our inspection and acceptance.

NOTICES AND DISCLAIMERS:

We reserve the right to make changes without notice in our products and in the information published about them. The statements and information in this publication are only for general guidance, and are not warranties or binding descriptions. Requests for more information are welcome. Full AFS terms and conditions are available upon request. The user assumes full responsibility for his or her applications. THERE IS NO WARRANTY OF FITNESS FOR A PARTICULAR PURPOSE. No one is authorised by our company to make oral warranties.

Note: Full Terms and Conditions are available on request.

Quality Certificates

Description	Part No
Certificate of Conformance	D1003-2
Insert Inspection Certificate Stainless Steel	D1003-1
Insert Inspection Certificate Inconel	D1003-5

Note: All charges are per line item, as certificates are issued per line item.

Table of Contents

		PAGE
Introduction		2
Standard Kits	Metric	3
Standard Kits	Inch	5
Sparkplug / Plugsaver Kits		7
Replacement Insert Packets for Kits and Merchandiser	Metric	8
Replacement Insert Packets for Kits and Merchandiser	Inch	9
Range Kits		11
Re-grip / Plugsaver / Gauges / Drill-Out / X-Out		12
Tangless Inserts - Free Running	Metric	13
Tangless Inserts - Screw Locking	Metric	14
Bulk Inserts - Free Running	Metric	15
Bulk Inserts - Free Running - Sparkplug / Lefthand Thread	Metric	20
Bulk Inserts - Free Running - UNC / UNF	Inch	21
Bulk Inserts - Free Running - BSW / BSF	Inch	24
Bulk Inserts - Free Running - BA / BSC / BSP / NPT	Inch	26
Bulk Inserts - Free Running - BSP / NPT / Special Threads / UN	Inch	27
Bulk Inserts - Free Running - UN / UNC LHT / Bicycle Threads	Inch	28
Bulk Inserts - Screw Locking	Metric	29
Bulk Inserts - Screw Locking - UNC / UNF	Inch	32
Bulk Inserts - Screw Locking - 8 TPI UN	Inch	34
Inserts - Stripfeed	Metric	35
Inserts - Stripfeed	Inch	36
Taps - Straight Flute Taps (Hand/Short Machine)	Metric	38
Taps - Straight Flute & Spiral Point Taps (Machine)	Metric	40
Taps - Straight Flute Taps (Hand/Short Machine)	Inch	41
Tap Coatings - TiN - Titanium Nitride Coating		44
Gauges - For Gauging STI Holes		45
Power Installation Tools		47
Standard Insertion Tools - Tool Fit Chart		49
Electric Installation Tools - Tool Fit Chart		52
Carbon Steel Bulk Keyserts	Metric	54
Carbon Steel Bulk Keyserts	Inch	55
Stainless Steel Bulk Keyserts	Metric	56
Stainless Steel Bulk Keyserts	Inch	57
Carbon & Stainless Steel Keysert - Replacement Packets		58
Recoil Tapper System	Metric	59
Recoil Tapper System	Inch	61
Tapper Installation Tools		62

Introduction

Alcoa Fastening Systems' (AFS) Recoil manufacturing operations are located in Australia, with sales and warehouse facilities strategically located in North America, Asia, and Europe. Extensive worldwide distribution, coupled with the company's manufacturing strategy, offers significant advantages to end users.

Alcoa Fastening Systems ensures a global consistency of quality design standards in manufacturing the full range of wire thread inserts in one production facility. Users around the world can be assured of high standards and the consistency of all AFS products. Inserts are manufactured in standard sizes for all metric and inch thread forms. A comprehensive design facility is available to ensure that non-standard inserts can be manufactured for special part requirements.

Prompt availability of products to customers worldwide is ensured by an efficient international freight service and a network of stocking distributors. Alcoa Fastening Systems is committed to the highest quality products and operating systems and employs a strict quality management system in accordance with:

- AS9100 accreditation
- ISO9001 accreditation
- TS16949 accreditation
- ADS
- TS157 approval
- ISO14001 Environmental Systems

Alcoa Fastening Systems will provide technical assistance to production engineers so that optimum installation efficiency can be achieved and maintained. Recoil brand coils are available to the following international and customer standards:

- NASM122076 Series - Free Running - UNC
- NASM21209 Series – Locking UNC and UNF
- BS7751 - Metric - Coarse
- BS7753
- MA3279,MA3280,MA3281 - Metric - Free Running
- AS6733 Series - UNF - Unplated
- AGS3600 Series - UNF - Cad. Plated - Self Locking
- General Electric - C981, N926 Series, N913
- DIN8140
- NASM124651 Series - Free Running - UNF
- NASM8846
- BS7752 - Metric - Fine
- BS4377
- MA3329,MA3330,MA3331 - Metric - Self Locking
- AS8455 Series - UNF - Cadmium Plated
- AGS3700 Series - Nimonic Alloy 90 - Self Locking
- LN9499, LN9039
- BAC112AE - Boeing

How to install Recoil inserts.



1. **DRILL:** Drill to clear out the damaged thread with drill size as specified on kit (if necessary).

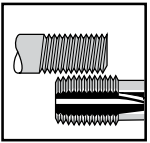

2. **CHECK:** Ensure tap thread matches bolt.

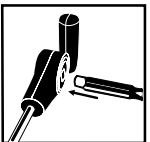

3. **TAP:** Place tap into tap wrench or use the square drive in the installation tool if provided. (Square drive tool only suitable for tapping non-ferrous alloys.)

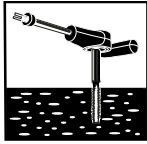

3a. **TAP HOLE:** Tap hole to the required depth using correct procedures (if unsure contact your dealer).

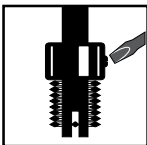

4. **SET TOOL:** Place insert on installation tool, positioning the adjustable top so that the insert tang is centered in the tang slot.

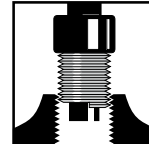

5. **INSTALL:** Wind insert in with light downward pressure until 1/4 to 1/2 turn below the surface.

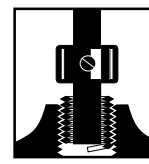

6. **TANG REMOVAL:** Do not attempt to twist tang off with tool. Lift tool from tang, turn tool 90° and tap down sharply. Use Tang Break Tool where supplied. For sparkplug and large fine thread inserts, use long nose pliers to pull tang out.

Thread Repair Kits Metric

Kit includes:

- High Speed Steel Drill
- HSS STI Tap
- Combination Tap and Installation Tool*
- Magnetic Tang Removal Tool
- Quantity of Inserts
- Easy to follow instructions
- All contained in a quality case



The Recoil Trade Series Kit includes only the best quality HSS taps which make them suitable for aluminium, magnesium, cast iron and most machinable steels. Everything you need for complete thread repair in one handy case.



Includes (sizes up to and including M12, 1/2")

1. New combo tap and installation tool
2. Magnetic Tang Break Tool (for easy tang removal in blind holes)
3. H.S.S. Drill

Thread Size	Metric Coarse 35000+ Part No.		Metric Medium 37000+ Part No.		Metric Extra Fine 38000+ Part No.		Inserts per Kit	Price per Kit
M2 - 0.4	35028	*					15	109.51
M2.2 - 0.45	35018	*					15	105.65
M2.5 - 0.45	35258	*					15	77.30
M3 - 0.5	35038	*					15	69.58
M3.5 - 0.6	35358	*					15	69.58
M4 - 0.7	35048	*					15	55.65
M5 - 0.8	35058	*					15	46.38
M6 - 1	35068	*					15	46.38
M7 - 1	35078	*					15	57.97
M8 - 1			37088	*			15	63.78
M8 - 1.25	35088	*					15	55.65
M9 - 1			37098	*			15	77.30
M9 - 1.25	35098						15	69.58
M10 - 1					38108	*	15	85.04
M10 - 1.25			37108	*			10	75.37
M10 - 1.5	35108	*					10	70.72
M11 - 1					38118	*	10	96.63
M11 - 1.25			37118	*			10	96.63
M11 - 1.5	35118	*					10	86.98
M12 - 1					38120-1	*	10	184.05
M12 - 1.25					38128	*	10	98.16
M12 - 1.5			37128	*			10	90.44
M12 - 1.75	35128	*					10	88.12
M13 - 1.5			37138				6	127.55
M13 - 1.75	35138						6	115.96
M13 - 1.25					38138		6	140.44
M14 - 1.5			37148				6	119.81
M14 - 2	35148						6	115.96
M14 - 1.25					38148-1		6	119.81
M15 - 1.5			37158				6	141.11
M15 - 2	35158						6	141.72

* Drill and magnetic tangbreak tool included

Thread Repair Kits Metric

Thread Size	Metric Coarse 35000+ Part No.	Metric Medium 37000+ Part No.	Metric Extra Fine 38000+ Part No.	Inserts per Kit	Price per Kit
M16 - 1.5		37168		6	134.97
M16 - 2	35168			6	120.59
M18 - 1.5			38188	6	225.46
M18 - 2		37188		6	219.02
M18 - 2.5	35188			6	206.14
M20 - 1.5			38208	6	239.27
M20 - 2		37208		6	251.23
M20 - 2.5	35208			6	244.79
M22 - 1.5			38220	5	282.22
M22 - 2		37220		5	282.22
M22 - 2.5	35220			5	276.08
M24 - 1.5			38240	5	392.65
M24 - 2		37240		5	392.65
M24 - 3	35240			5	349.70
M26 - 1.5			38260	5	454.00
M27 - 1.5			38270	5	454.00
M27 - 2		37270		5	454.00
M27 - 3	35270			5	429.46
M30 - 1.5			38300	5	546.03
M30 - 2		37300		5	539.89
M30 - 3	35300-3			5	527.62
M30 - 3.5	35300			5	527.62
M33 - 2		37330		5	613.51
M33 - 3.5	35330			5	601.24
M36 - 1.5			38360	4	699.40
M36 - 3		37360		4	699.40
M36 - 4	35360			4	681.00
M39 - 2			38390	4	809.83
M39 - 3		37390		4	809.83
M39 - 4	35390			4	797.56
M42 - 2			38420	4	932.54
M42 - 3		37420		4	932.54
M42 - 4.5	35420			4	920.27
M42 - 4	35420-4			4	920.27
M45 - 4.5	35450			4	1,046.67

Left Hand Threads Kits			
Thread Size	Part No.	Inserts per Kit	Price/Kit
M6 - 1	35068LH	15	245.40
M8 - 1.25	35088LH	15	245.40
M10 - 1.5	35108LH	10	245.40
M12 - 1.75	35128LH	5	245.40

Pilot Nose Taps Kits			
Thread Size	Part No.	Inserts per Kit	Price/Kit
M6 - 1	35063	15	79.76
M8 - 1.25	35083	15	92.03
M10 - 1.5	35103	10	110.43
M10 - 1.25	37103	10	110.43
M12 - 1.75	35123	10	120.25

* Drill and magnetic tangbreak tool included



Australian Price List Effective July 2013
All prices are exclusive of GST

Thread Repair Kits Inch

Thread Size	UNC 33000+		UNF 34000+		Inserts per Kit	Price per Kit
	Part No.	*	Part No.	*		
#2 - 56	33528	*			15	70.86
#3 - 48	33538	*			15	70.86
#3 - 56			34538	*	15	70.86
#4 - 40	33548	*			15	63.78
#4 - 48			34548	*	15	70.86
#5 - 40	33558	*			15	63.78
#6 - 32	33568	*			15	60.30
#6 - 40			34568	*	15	105.52
#8 - 32	33588	*			15	60.30
#8 - 36			34588	*	15	105.51
#10 - 24	33608	*			15	54.50
#10 - 32			34608	*	15	54.81
#12 - 24	33628	*			15	60.56
#12 - 28			34628	*	15	60.56
1/4 - 20	33048	*			15	48.71
1/4 - 28			34048	*	15	48.71
5/16 - 18	33058	*			15	52.19
5/16 - 24			34058	*	15	52.19
3/8 - 16	33068	*			10	64.94
3/8 - 24			34068	*	10	64.94
7/16 - 14	33078	*			10	75.37
7/16 - 20			34078	*	10	75.37
1/2 - 13	33088	*			10	83.49
1/2 - 20			34088	*	10	83.49
9/16 - 12	33098				6	119.81
9/16 - 18			34098		6	114.11
5/8 - 11	33108				6	126.26
5/8 - 18			34108		6	126.26
11/16 - 11	33110				5	190.19
3/4 - 16			34128		5	199.70
3/4 - 10	33128				5	199.70
7/8 - 14			34140		5	233.13
7/8 - 9	33140				5	233.13
1" - 12			34160		5	288.35
1" - 8	33160				5	288.35
1" - 14			34160-14		5	300.62
1 1/8 - 7	33180				5	417.19
1 1/8 - 12			34180		5	417.19
1 1/4 - 7	33200				5	496.94
1 1/4 - 12			34200		5	496.94
1 3/8 - 6	33220				5	503.08
1 3/8 - 12			34220		5	503.08
1 1/2 - 6	33240				4	638.05
1 1/2 - 12			34240		4	638.05

* Drill and magnetic tangbreak tool included



Australian Price List Effective July 2013
All prices are exclusive of GST

Thread Repair Kits Inch

BSW 32000+				
Size	Part No.		Inserts per Kit	Price/Kit
1/8 - 40	32028	*	15	73.43
3/16 - 24	32038	*	15	61.84
1/4 - 20	32048	*	15	57.97
5/16 - 18	32058	*	15	60.55
3/8 - 16	32068	*	10	74.73
7/16 - 14	32078	*	10	86.32
1/2 - 12	32088	*	10	94.05
9/16 - 12	32098		6	122.40
5/8 - 11	32108		6	131.42
3/4 - 10	32128		6	199.69
7/8 - 9	32140		6	231.90
1" - 8	32160		5	294.49
1 1/8 - 7	32180		5	429.46
1 1/4 - 7	32200		5	503.08
1 3/8 - 6	32220		5	521.48
1 1/2 - 6	32240		5	656.46

BSP 31000+				
Size	Part No.		Inserts per Kit	Price/Kit
1/8 - 28	31028	*	10	113.37
1/4 - 19	31048		10	150.74
3/8 - 19	31068		6	213.87
1/2 - 14	31080		5	276.08
5/8 - 14	31100		5	380.38
3/4 - 14	31120		5	423.32
1" - 11	31160		5	582.84

SPECIALS UNEF				
Size	Part No.		Inserts per Kit	Price /Kit
1/4 - 32	34040-32		10	79.76
7/16 - 24	34070-24		10	128.84
9/16 - 20	34090-20		5	110.43

* Drill and magnetic tangbreak tool included

BSF 30000+				
Size	Part No.		Inserts per Kit	Price/Kit
3/16 - 32	30038	*	15	87.61
1/4 - 26	30048	*	15	85.04
5/16 - 22	30058	*	15	86.08
3/8 - 20	30068	*	10	96.63
7/16 - 18	30078	*	10	117.24
1/2 - 16	30080	*	10	128.84
9/16 - 16	30090		6	148.16
5/8 - 14	30100		6	181.66
3/4 - 12	30120		6	295.04
7/8 - 11	30140		5	342.34
1" - 10	30160		5	404.92
1 1/4 - 9	30200		5	668.73

BA 30500+				
Size	Part No.		Inserts per Kit	Price/Kit
0 BA	30508	*	15	109.51
2 BA	30528	*	15	109.51
4 BA	30548	*	15	109.51
6 BA	30568	*	15	109.51

8 TPI UN 36180+				
Size	Part No.		Inserts per Kit	Price/Kit
1 1/8 - 8	36180		5	435.59
1 1/4 - 8	36200		5	539.89
1 3/8 - 8	36220		5	625.78
1 1/2 - 8	36240		4	687.13
1 5/8 - 8	36260		4	834.38
1 3/4 - 8	36280		4	944.81
1 7/8 - 8	36300		4	1,049.10
2" - 8	36320		4	1,165.67

CUMMINS-HEAD BOLT				
Size	Part No.		Inserts per Kit	Price/Kit
11/16 - 11	34110-16		10	239.27

BSC / BRASS 36000+				
Size	Part No.		Inserts per Kit	Price/Kit
5/16 - 26	36508	*	15	88.89
3/8 - 26	36608	*	10	96.63
7/16 - 26	36708	*	5	117.24
1/2 - 26	36808	*	5	128.84

NPT 36000+				
Size	Part No.		Inserts per Kit	Price/Kit
1/8 - 27	36028		10	141.72
1/4 - 18	36048		10	193.26
3/8 - 18	36068		6	270.56
1/2 - 14	36080		5	337.43
3/4 - 14	36128		5	460.13
1 - 11 1/2	36160		5	638.05

LEFT HAND THREAD KITS				
Size	Part No.		Inserts per Kit	Price/Kit
1/4 - 20	33048LH	*	15	245.40
5/16 - 18	33058LH	*	15	245.40
3/8 - 16	33068LH	*	10	245.40
7/16 - 14	33078LH	*	5	245.40
1/2 - 13	33088LH	*	5	245.40

HARLEY				
Size	Part No.		Inserts per Kit	Price/Kit
1/4 - 24	34048-24		10	79.76
7/16 - 16	34078-16		5	116.57

CARBURETTOR				
Size	Part No.		Inserts per Kit	Price/Kit
7/8 - 20	34140-20		5	306.76
1" - 20	34160-20		5	332.40
7/8 - 12	34140-12		5	337.43



Sparkplug/Plugsaver Kits

For Thread Strengthening or Repair



SPARKPLUG 38000+	TRADE SERIES KIT	STD KIT		Inserts per Kit	Price per Kit
Size	Part No.	Part No.	Description		
M10 - 1	38108-2		Contains 10 x M10-1 x 1.5D inserts & includes Hand Tool, Pilot Nose Tap and Magnetic Tangbreak Tool	10	106.94
M12 - 1.25	38120-2		Contains 5 x M12-1.25 x 1D, and 1.5D inserts & includes Hand Tool, Pilot Nose Tool and Magnetic Tangbreak Tool	10	123.68
M14 - 1.25		38140	Contains 5 x 3/4", and 3/8" Sparkplug inserts & includes extracting tool in large tin	10	109.21
M14 - 1.25	38148-2		Contains 5 x 3/4", and 3/8" Sparkplug inserts	10	112.09
M18 - 1.5	38188		NB: Spark Plug kits contain pilot nose taps	4	225.46
SPARKPLUG METRIC M14 - 1.25		38147	Contains 3 x 8.4, 3 x 12.4 & 3 x 16.4mm inserts	4	127.61
EXHAUST ANALYSIS KIT		38188-1X	NB: This kit contains high temperature Inconel Inserts	5	219.02

Sparkplug kits contain a Pilot nose Tap.
No drilling is required.

PLUGSAVER 38000+ - An alternative method of thread repair for standard and taper seat plugs, using Thinwall inserts.		
Part No.	Description	Price per Kit
38148	COMPLETE REPAIR KIT CONTAINS: 1 x 98146 - Expander, 1 x 98145 - Pilot Nose Tap 2 x 98142 - Plugsaver M14 - 1.25 x 9.5mm long 2 x 98143 - Plugsaver M14 - 1.25 x 12.7mm long 2 x 98144 - Plugsaver M14 - 1.25 x 19mm long	87.78
98142RP	Short Reach Insert (PKT OF 5) 9.5mm	25.72
98143RP	Medium Reach Insert (PKT OF 5) 12.7mm	30.51
98144RP	Long Reach Insert (PKT OF 5) 19mm	35.29
98145	Pilot Nose Tap	60.74
98146	Expanding Tool	14.11
98147RP	2 x 3/8", 2 x 1/2", 2 x 3/4" Inserts	36.48
98140T	F250 Kit	147.24



Australian Price List Effective July 2013
All prices are exclusive of GST

Replacement Insert Packets for Kits and Merchandiser - Inch

Most inserts in replacement packets are 1.5 x Diameter. For example - M6 is 9mm Long, 1/4" is 3/8" long.

UNC 23000+			
Thread Size	Part No.	Ins/Pkt	Price/Pkt
#2 - 56 x 1D	23522	10	8.87
#2 - 56 x 1.5D	23523	10	9.61
#3 - 48 x 1.5D	23533	10	15.96
#4 - 40 x 1D	23542	10	6.80
#4 - 40 x 1.5D	23543	10	7.25
#4 - 40 x 2D	23544	10	7.69
#5 - 40 x 1D	23552	10	6.80
#5 - 40 x 1.5D	23553	10	7.25
#5 - 40 x 2D	23554	10	7.69
#6 - 32 x 1D	23562	10	6.80
#6 - 32 x 1.5D	23563	10	7.25
#6 - 32 x 2D	23564	10	7.69
#8 - 32 x 1D	23582	10	6.80
#8 - 32 x 1.5D	23583	10	7.25
#8 - 32 x 2D	23584	10	7.69
#10 - 24 x 1D	23602	10	6.80
#10 - 24 x 1.5D	23603	10	7.25
#10 - 24 x 2D	23604	10	7.69
#12 - 24 x 1D	23622	10	7.83
#12 - 24 x 1.5D	23623	10	8.13
1/4 - 20 x 1D	23042	10	7.83
1/4 - 20 x 1.5D	23043	10	8.13
1/4 - 20 x 2D	23044	10	9.16
5/16 - 18 x 1D	23052	10	8.58
5/16 - 18 x 1.5D	23053	10	9.02
5/16 - 18 x 2D	23054	10	9.72
3/8 - 16 x 1D	23062	10	11.53
3/8 - 16 x 1.5D	23063	10	12.71
3/8 - 16 x 2D	23064	10	14.79
7/16 - 14 x 1D	23072	10	14.19
7/16 - 14 x 1.5D	23073	10	15.08
7/16 - 14 x 2D	23074	10	16.85
1/2 - 13 x 1D	23082	10	16.26
1/2 - 13 x 1.5D	23083	10	17.50
1/2 - 13 x 2D	23084	10	19.52
9/16 - 12 x 1D	23092	5	10.34
9/16 - 12 x 1.5D	23093	5	11.82
5/8 - 11 x 1D	23102	5	13.89
5/8 - 11 x 1.5D	23103	5	17.00
11/16 - 11 x 1.5D	23113	5	22.47
3/4 - 10 x 1D	23122	5	19.95
3/4 - 10 x 1.5D	23123	5	23.65
7/8 - 9 x 1.5D	23143	3	23.94
1" - 8 x 1.5D	23163	3	30.15
1 1/8 - 7 x 1D	23182	1	14.03
1 1/8 - 7 x 1.5D	23183	1	14.78
1 1/4 - 7 x 1D	23202	1	15.44
1 1/4 - 7 x 1.5D	23203	1	16.85
1 3/8 - 6 x 1.5D	23223	1	17.74
1 1/2 - 6 x 1D	23242	1	19.66
1 1/2 - 6 x 1.5D	23243	1	23.65

UNF 24000+			
Thread Size	Part No.	Ins/Pkt	Price/Pkt
#3 - 56 x 1.5D	24533	10	15.96
#4 - 48 x 1.5D	24543	10	7.25
#6 - 40 x 1D	24562	10	6.80
#6 - 40 x 1.5D	24563	10	7.25
#8 - 36 x 1.5D	24583	10	7.25
#10 - 32 x 1D	24602	10	6.80
#10 - 32 x 1.5D	24603	10	7.25
#10 - 32 x 2D	24604	10	7.69
#12 - 28 x 1.5D	24623	10	8.13
1/4 - 28 x 1D	24042	10	7.83
1/4 - 28 x 1.5D	24043	10	8.13
1/4 - 28 x 2D	24044	10	9.16
5/16 - 24 x 1D	24052	10	8.58
5/16 - 24 x 1.5D	24053	10	9.02
5/16 - 24 x 2D	24054	10	9.91
3/8 - 24 x 1D	24062	10	11.53
3/8 - 24 x 1.5D	24063	10	12.71
3/8 - 24 x 2D	24064	10	14.79
7/16 - 20 x 1D	24072	10	14.19
7/16 - 20 x 1.5D	24073	10	15.08
7/16 - 20 x 2D	24074	10	16.85
1/2 - 20 x 1D	24082	10	16.26
1/2 - 20 x 1.5D	24083	10	17.50
1/2 - 20 x 2D	24084	10	19.52
9/16 - 18 x 1D	24092	5	10.34
9/16 - 18 x 1.5D	24093	5	11.82
5/8 - 18 x 1D	24102	5	13.89
5/8 - 18 x 1.5D	24103	5	17.00
3/4 - 16 x 1D	24122	5	19.95
3/4 - 16 x 1.5D	24123	5	23.65
7/8 - 14 x 1.5D	24143	3	23.94
1" - 12 x 1.5D	24163	3	30.15
1 1/8 - 12 x 1D	24182	1	14.03
1 1/8 - 12 x 1.5D	24183	1	14.78
1 1/4 - 12 x 1D	24202	1	15.44
1 1/4 - 12 x 1.5D	24203	1	16.85
1 3/8 - 12 x 1.5D	24223	1	17.74
1 1/2 - 12 x 1D	24242	1	19.66
1 1/2 - 12 x 1.5D	24243	1	23.65



Replacement Insert Packets for Kits and Merchandiser - Inch

Most inserts in replacement packets are 1.5 x Diameter. For example - M6 is 9mm Long, 1/4" is 3/8" long.

BSF 20000+			
Thread Size	Part No.	Ins/ Pkt	Price/ Pkt
3/16 - 32 x 1D	20032	10	6.86
3/16 - 32 x 1.5D	20033	10	7.31
3/16 - 32 x 2D	20034	10	7.72
5/16 - 22 x 1.5D	20052	10	7.98
5/16 - 22 x 1D	20053	10	9.16
5/16 - 22 x 2D	20054	10	10.94
3/8 - 20 x 1D	20062	10	11.24
3/8 - 20 x 1.5D	20063	10	12.71
3/8 - 20 x 2D	20064	10	14.49
7/16 - 18 x 1D	20072	10	13.89
7/16 - 18 x 1.5D	20073	10	15.08
7/16 - 18 x 2D	20074	10	16.55
1/2 - 16 x 1D	20082	10	16.41
1/2 - 16 x 1.5D	20083	10	17.50
1/2 - 16 x 2D	20084	10	20.70
9/16 - 16 x 1.5D	20093	5	11.82
5/8 - 14 x 1.5D	20103	5	17.74
3/4 - 12 x 1.5D	20123	5	23.65
7/8 - 11 x 1.5D	20143	3	23.94
1" - 10 x 1.5D	20163	3	30.15

BA 20500+			
Thread Size	Part No.	Ins/ Pkt	Price/ Pkt
0BA x 1.5D	20503	10	13.01
2BA x 1.5D	20523	10	13.01
4BA x 1.5D	20543	10	13.01
6BA x 1.5D	20563	10	13.01

SPARKPLUG 28000+			
Thread Size	Part No.	Ins/ Pkt	Price/ Pkt
M10 - 1 x 1D	28102	10	11.24
M10 - 1 x 1.5D	28103	10	12.71
M10 - 1 x 2D	28104	10	14.49
M10 - 1 x 6.8mm	28107	10	11.82
M10 - 1 x .339"	28108	10	11.47
M10 - 1 x 1/2"	28109	10	13.00
M14 - 1.25 x 3/4"	28140	10	19.62
M14 - 1.25 x 7/16"	28147	10	12.52
M14 - 1.25 x 3/8"	28148	10	9.80
M14 - 1.25 x 1/2"	28149	10	14.93
M18 - 1.5 x 1/2"	28189	5	13.89

BSP 21000+			
Thread Size	Part No.	Ins/ Pkt	Price/ Pkt
1/8 - 28 x 1D	21022	10	16.55
1/8 - 28 x 1.5D	21023	10	19.39
1/8 - 28 x 12D	21024	10	26.01
1/4 - 19 x 1D	21042	10	23.65
1/4 - 19 x 1.5D	21043	10	28.38
1/4 - 19 x 2D	21044	10	37.84
3/8 - 19 x 1D	21062	10	26.01
3/8 - 19 x 1.5D	21063	10	35.47
3/8 - 19 x 2D	21064	10	49.66
1/2 - 14 x 1.5D	21082	5	23.06
1/2 - 14 x 1.5D	21083	5	28.97
1/2 - 14 x 1.5D	21084	5	37.84
3/4 - 14 x 1.5D	21123	5	42.57
1" - 11 x 1.5D	21163	3	33.70

NPT 26000+			
Thread Size	Part No.	Ins/ Pkt	Price/ Pkt
1/8 - 27 x 1.5D	26023	10	19.39
1/4 - 18 x 1.5D	26043	10	28.38
3/8 - 18 x .407D	26063	10	35.47
1/2 - 14 x 1.5D	26083	5	28.97
3/4 - 14 x .553D	26123	5	42.57
1 - 11 1/2 x 1.65D	26163	3	33.70

BICYCLE DERAILLEUR KIT			
Thread Size	Part No.	Ins/ Pkt	Price/ Pkt
M10 - 1 x 6.8mm	28107	10	11.82

BICYCLE CRANK KIT			
Thread Size	Part No.	Ins/ Pkt	Price/ Pkt
9/16 - 20 x 1/2	24090-20	10	12.07
9/16 - 20 x 1/2	24090-20LH	10	16.06

BSW 22000+			
Thread Size	Part No.	Ins/ Pkt	Price/ Pkt
1/8 - 40 x 1.5D	22023	10	8.28
3/16 - 24 x 1.5D	22033	10	7.31
1/4 - 20 x 1.5D	22043	10	8.13
5/16 - 18 x 1.5D	22053	10	9.16
3/8 - 16 x 1.5D	22063	10	12.71
7/16 - 14 x 1.5D	22073	10	15.08
1/2 - 12 x 1D	22082	10	16.41
1/2 - 12 x 1.5D	22083	10	17.50
1/2 - 12 x 2D	22084	10	20.70
9/16 - 12 x 1.5D	22093	5	11.82
5/8 - 11 x 1.5D	22103	5	17.74
3/4 - 10 x 1.5D	22123	5	23.65
7/8 - 9 x 1.5D	22143	3	23.94
1" - 8 x 1.5D	22163	3	30.15

BSC 26500+			
Thread Size	Part No.	Ins/ Pkt	Price/ Pkt
5/16 - 26 x 1.5D	26503	10	14.66
3/8 - 26 x 1.5D	26603	10	17.03
7/16 - 26 x 1.5D	26703	10	23.65
1/2 - 26 x 1.5D	26803	10	37.84

EXHAUST ANALYSIS 28000+				
Thread Size	Part No.	Length	Ins/ Pkt	Price/Pkt
M18 - 1.5	28181X	9mm	5	5.91

NB: This pkt contains 5 high temperature Inconel Inserts



Range Kits

Recoil range kits contain a selection of Recoils most popular sizes. It provides you with an all in one workshop solution for Multi Diameter thread repairs. It's ideal for garages and other workshops where thread repairs are often undertaken.

Standard Kit Content*

- High speed steel (HSS) intermediate STI taps
- Quantity of inserts 1.5D length
- New Combo Tap Drive and Installation Tool*
- New Magnetic Tang Break Tool*
- Drill-bit*

* Kit contents differ depending on thread form and diameters



POPULAR SIZES				
Thread/Type	Part No.	Includes	Price per Kit	Sizes per Kit
UNC	33004R	1/4, 5/16, 3/8, 7/16, 1/2	324.67	5
UNF	34004R	1/4, 5/16, 3/8, 7/16, 1/2	330.47	5
METRIC	35003R	M4, 5, 6, 8-1.25, 10-1.5	276.55	5
METRIC	35004R	M5, 6, 8-1.25, 10-1.5, 12-1.75	276.55	5
METRIC	35005R	M6, 8-1.25, 10-1.5, 12-1.75, 16-2	381.49	5

INCH				
Thread/Type	Part No.	Includes	Price per Kit	Sizes per Kit
BSF	30004R	1/4, 5/16, 3/8, 7/16, 1/2	464.98	5
BSP	31004R	1/8, 1/4, 3/8	691.08	3
BSW	32004R	1/4, 5/16, 3/8, 7/16, 1/2	336.27	5
UNC	33002R	4-40, 6-32, 8-32, 10-24UNC & 10-32UNF	279.39	5
BSC/BRASS	36001R	1/4, 5/16, 3/8, 7/16, 1/2	464.98	5
NPT	36004R	1/8, 1/4, 3/8, 1/2	484.76	4

INCH - MINI RANGE KIT				
Thread/Type	Part No.	Includes	Price per Kit	Sizes per Kit
UNC	33001	1/4, 5/16, 3/8	157.92	3
HARLEY	34008	1/4-24 & 7/16-16 Harley, 3/8-20 BSF	259.52	3
UNF	34001	1/4, 5/16, 3/8	157.92	3

METRIC				
Thread/Type	Part No.	Includes	Price per Kit	Sizes per Kit
METRIC	33005R	M6, 8-1.25, 10-1.5, 12-1.75, 14-1.25PN	344.55	5
METRIC	33007R	M4, 5, 6, 8-1.25	194.36	4
FINE	37000R	M8-1, 10-1, 10-1.25, 12-1.25, 12-1.5	398.88	5
METRIC	37003R	M6, 8-1.25, 10-1.5, 12-1.75, 14-2	365.25	5
METRIC	37004R	M4, 6, 8-1.25, 10-1.5, 12-1.75	316.56	5
M/CYCLE	38006R	M6, 8-1.25, 10-1.25, 12-1.25PN, 14-1.25PN	390.76	5
OPE	38007R	M5, 6, 8-1.25, 14-1.25PN, 1/4-20	350.18	5

BICYCLE CRANK & DERAILER				
Thread/Type	Part No.	Includes	Price per Kit	Sizes per Kit
CRANK KIT	34096-20	1 EACH - LEFT & RIGHT HAND	108.22	2
		5 - 9/16-20X1/2" LEFT HAND INSERTS		
		5 - 9/16-20X1/2" RIGHT HAND INSERTS		
		1 - INSTALLATION TOOL		
DERAILLEUR KIT	38102	THREAD KIT M10-1 x 6.8mm	75.77	1
BICYCLE RANGE	34005	9/16-20 RH & LH, M10-1 x 6.8mm Derailleur	183.99	3

Australian Price List Effective July 2013

All prices are exclusive of GST

Re-Grip / Plugsaver / Gauges / Drill-Out / X-Out

RE-GRIP - Friction Enhancing Compound

Part No.	Size	Price/Pkt
11111	15ml tube on backing card	14.60

PITCH/TPI GAUGES

Part No.	Size	Price/Pkt
65000	Metric	18.79
63000	Inch	18.79
69000	1 each Metric and Inch set	32.60

POWER EXTRACTORS - For removal broken Bolts, studs and screws

DRILL OUT - Power extractor for broken Bolts or studs

Micro Drill-Out Power Extractors	Size	Price/Pkt
P125	#5, #6, M3	24.03
P164	#8 & M4	26.07
P190	#10, #12 & M5	28.08
P236	1/4" & M6	30.09
Drill-Out Power Extractors	Size	Price/Pkt
P250	1/4" or 6mm	30.09
P312	5/16" or 8mm	33.10
P375	3/8" or 10mm	36.11
P500	1/2" or 12mm	42.15
Drill-Out Range Kits	Size	Price/Pkt
P450	Kit comprises P125, P164, P190, P230	90.36
P401	Kit comprises P250, P312, P375, P500	120.51
P701	Kit comprises P125, P164, P190, P236, P312, P375, P500	168.72

X-OUT - Extractors for removing all types of screws

Part No.	Size	Price/Pkt
2019P8001	Set of 3 X-Outs Removes # 8 to # 14 screws	50.18
2001P8001	Single X-Out Removes # 6 to # 8 screws	22.05
2003P8001	Single X-Out Removes # 10 to # 14 screws	24.06



Re - Grip



Thread Pitch Gauges



Drill - Out



X - Out

Tangless Inserts

Only Supplied in Full Bag Quantities

Tangless® Inserts:

- FOD-Free Design: No tangs to break off, retrieve...or lose.
- Approved for use on military programs by NASM8846 and NAS1130.
- Cost Reduction: Significantly decreased installation and inspection time.
- Bi-directional design eliminates insert orientation requirement.
- Quick, non-destructive removal prevents damage to castings.



Metric Tangless CoilThread Inserts are made of cold-rolled Type 304 stainless steel wire (AS7245 and MA1565), work-hardened to a tensile strength above 200,000 psi, a hardness of HRC 43-50 and an exceedingly smooth (8-16 micro-inches) surface finish. Metric Tangless Inserts are designed to replace tanged helical coil inserts as specified in MA3279 through MA3281 (standard thread) and MA3329 through MA3331 (locking thread). They install in standard STI tapped holes per MA1567. Installed inserts provide a finished thread meeting the requirements of FED-STD-H28, M Profile, Tolerance Classes 4H or 5H, as well as ISO metric thread specifications, and accept standard or MJ profile bolts or screws.

TANGLESS - METRIC FREE RUNNING SERIES								
Thread Nominal	Nominal Length	Recoil Part No.	Free Coil Dia Min /Max.	Number of Coils	Length (mm)	PRICE EACH PER INSERT (1000/BAG)		
						1000+	5000+	KATO Part No.
M2.5 - 0.45	1D	TL05252		3.38	2.5	0.46	0.34	2TNM2.5x.45C-2.5
	1.5D	TL05253	3.20	5.63	3.75	0.49	0.36	2TNM2.5x.45C-3.8
	2D	TL05254	3.70	8.00	5	0.51	0.38	2TNM2.5x.45C-5
	2.5D	TL05255 ▲		10.50	6.25	0.56	0.42	2TNM2.5x.45C-6.3
	3D	TL05256 ▲		12.75	7.5	0.61	0.45	2TNM2.5x.45C-7.5
M3 - 0.5	1D	TL05032		3.75	3	0.41	0.31	2TNM3x.5C-3
	1.5D	TL05033	3.80	6.38	4.5	0.44	0.33	2TNM3x.5C-4.5
	2D	TL05034	4.35	8.88	6	0.46	0.34	2TNM3x.5C-6
	2.5D	TL05035 ▲		11.38	7.5	0.50	0.38	2TNM3x.5C-7.5
	3D	TL05036 ▲		13.88	9.0	0.56	0.42	2TNM3x.5C-9
M4 - 0.7	1D	TL05042		3.63	4	0.41	0.31	2TNM4x.7C-4
	1.5D	TL05043	5.05	6.13	6	0.44	0.33	2TNM4x.7C-6
	2D	TL05044	5.60	8.63	8	0.46	0.34	2TNM4x.7C-8
	2.5D	TL05045 ▲		11.13	10	0.50	0.38	2TNM4x.7C-10
	3D	TL05046 ▲		13.63	12	0.56	0.42	2TNM4x.7C-12
M5 - 0.8	1D	TL05052		4.13	5	0.41	0.31	2TNM5x.8C-5
	1.5D	TL05053	6.20	6.88	7.5	0.44	0.33	2TNM5x.8C-7.5
	2D	TL05054	6.80	9.63	10	0.46	0.34	2TNM5x.8C-10
	2.5D	TL05055 ▲		12.38	12.5	0.52	0.39	2TNM5x.8C-12.5
	3D	TL05056 ▲		15.13	15	0.59	0.44	2TNM5x.8C-15
M6 - 1	1D	TL05062		4.00	6	0.45	0.34	2TNM6x1C-6
	1.5D	TL05063	7.40	6.75	9	0.50	0.38	2TNM6x1C-9
	2D	TL05064	7.95	9.50	12	0.52	0.39	2TNM6x1C-12
	2.5D	TL05065 ▲		12.125	15	0.57	0.42	2TNM6x1C-15
	3D	TL05066 ▲		14.875	18	0.62	0.47	2TNM6x1C-18

Thread Nominal	Nominal Length	Recoil Part No.	Free Coil Dia Min /Max.	Number of Coils	Length (mm)	PRICE EACH PER INSERT (500/BAG)		
						500+	5000+	KATO Part No.
M8 - 1.25	1D	TL05082		4.500	10	0.48	0.36	2TNM8x1.25C-8
	1.5D	TL05083	9.80	7.38	12	0.54	0.41	2TNM8x1.25C-12
	2D	TL05084	10.35	10.25	16	0.60	0.45	2TNM8x1.25C-16
	2.5D	TL05085 ▲		13.25	18	0.74	0.56	2TNM8x1.25C-20
	3D	TL05086 ▲		16.13	20	0.89	0.67	2TNM8x1.25C-24
M10 - 1.5	1D	TL05102		4.90	10	0.67	0.50	2TNM10x1.5C-10
	1.5D	TL05103	11.95	8.00	15	0.76	0.58	2TNM10x1.5C-15
	2D	TL05104	12.50	11.10	20	0.87	0.66	2TNM10x1.5C-20
	2.5D	TL05105 ▲		14.25	25	1.05	0.78	2TNM10x1.5C-25
	3D	TL05106 ▲		17.38	30	1.24	0.94	2TNM10x1.5C-30

▲ Denotes non-popular parts - Price On Application. Minimum quantities and order values may apply.

Only supplied in full bag quantities.

Dry film lubing and plating available.

Australian Price List Effective July 2013

All prices are exclusive of GST

Tangless Inserts - Screw Locking

Only Supplied in Full Bag Quantities

TANGLESS - SCREW LOCKING								
Thread Nominal	Nominal Length	Recoil Part No.	Free Coil Dia Min /Max.	Number of Coils	Length (mm)	PRICE EACH PER INSERT (1000/BAG)		
						1000+	5000+	KATO Part No.
M2.5 - 0.45	1D	TL15252		3.38	2.5	POA	POA	2TLM2.5x.45C-2.5
	1.5D	TL15253	3.20	5.63	3.75	POA	POA	2TLM2.5x.45C-3.8
	2D	TL15254	3.70	8.00	5	POA	POA	2TLM2.5x.45C-5
	2.5D	TL15255 ▲		10.50	6.25	POA	POA	2TLM2.5x.45C-6.3
	3D	TL15256 ▲		12.75	7.5	POA	POA	2TLM2.5x.45C-7.5
M3 - 0.5	1D	TL15032		3.75	3	0.50	0.38	2TLM3x0.5C-3
	1.5D	TL15033	3.80	6.38	4.5	0.53	0.39	2TLM3x0.5C-4.5
	2D	TL15034	4.35	8.88	6	0.56	0.41	2TLM3x0.5C-6
	2.5D	TL15035 ▲		11.38	7.5	0.60	0.45	2TLM3x0.5C-7.5
	3D	TL15036 ▲		13.88	9.0	0.67	0.51	2TLM3x0.5C-9
M4 - 0.7	1D	TL15042		3.63	4	0.50	0.38	2TLM4x0.7C-4
	1.5D	TL15043	5.05	6.13	6	0.53	0.39	2TLM4x0.7C-6
	2D	TL15044	5.60	8.63	8	0.56	0.41	2TLM4x0.7C-8
	2.5D	TL15045 ▲		11.13	10	0.60	0.45	2TLM4x0.7C-10
	3D	TL15046 ▲		13.63	12	0.67	0.51	2TLM4x0.7C-12
M5 - 0.8	1D	TL15052		4.13	5	0.50	0.38	2TLM5x0.8C-5
	1.5D	TL15053	6.20	6.88	7.5	0.53	0.39	2TLM5x0.8C-7.5
	2D	TL15054	6.80	9.63	10	0.56	0.41	2TLM5x0.8C-10
	2.5D	TL15055 ▲		12.38	12.5	0.63	0.47	2TLM5x0.8C-12.5
	3D	TL15056 ▲		15.13	15	0.71	0.53	2TLM5x0.8C-15
M6 - 1	1D	TL15062		4.00	6	0.54	0.41	2TLM6x1C-6
	1.5D	TL15063	7.40	6.75	9	0.60	0.45	2TLM6x1C-9
	2D	TL15064	7.95	9.50	12	POA	0.47	2TLM6x1C-12
	2.5D	TL15065 ▲		12.13	15	0.68	0.51	2TLM6x1C-15
	3D	TL15066 ▲		14.88	18	0.75	0.56	2TLM6x1C-18

Thread Nominal	Nominal Length	Recoil Part No.	Free Coil Dia Min /Max.	Number of Coils	Length (mm)	PRICE EACH PER INSERT (1000/BAG)		
						500+	5000+	KATO Part No.
M8 - 1.25	1D	TL15082		4.50	10	0.57	0.43	2TLM8x1.25C-8
	1.5D	TL15083	9.80	7.38	12	0.65	0.49	2TLM8x1.25C-12
	2D	TL15084	10.35	10.25	16	0.72	0.54	2TLM8x1.25C-16
	2.5D	TL15085 ▲		13.25	18	0.89	0.68	2TLM8x1.25C-20
	3D	TL15086 ▲		16.13	20	1.06	0.81	2TLM8x1.25C-24
M10 - 1.5	1D	TL15102		4.90	10	0.81	0.60	2TLM10x1.5C-10
	1.5D	TL15103	11.95	8.00	15	0.92	0.69	2TLM10x1.5C-15
	2D	TL15104	12.50	11.10	20	1.04	0.79	2TLM10x1.5C-20
	2.5D	TL15105 ▲		14.25	25	1.26	0.94	2TLM10x1.5C-25
	3D	TL15106 ▲		17.38	30	1.49	1.13	2TLM10x1.5C-30

▲ Denotes non-popular parts - Price On Application. Minimum quantities and order values may apply.
Dry film lubing and plating available.

Tangless Inserts - Tooling



Hex Shank Insertion Tool

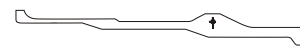

Replacement Pawl

HEX SHANK INSERTION TOOL - FREE RUNNING				HEX SHANK INSERTION TOOL - LOCKING				REPLACEMENT PAWL			
Size	Recoil Part No.	Kato Part No.	Price	Size	Recoil Part No.	Kato Part No.	Price	Size	Recoil Part No.	Kato Part No.	Price
M2.5 - 0.45	2CT10-M2.5F	2CT10-M2.5F	329.69	M2.5 - 0.45	2CT10-M2.5L	2CT10-M2.5L	329.69	M2.5 - 0.45	2CT10-M2.5P	2CT20-M2.5	130.31
M3 - 0.5	2CT10-M3F	2CT10-M3F	329.69	M3 - 0.5	2CT10-M3L	2CT10-M3L	329.69	M3 - 0.5	2CT10-M3P	2CT20-M3	130.31
M4 - 0.7	2CT10-M4F	2CT10-M4F	329.69	M4 - 0.7	2CT10-M4L	2CT10-M4L	329.69	M4 - 0.7	2CT10-M4P	2CT20-M4	130.31
M5 - 0.8	2CT10-M5F	2CT10-M5F	329.69	M5 - 0.8	2CT10-M5L	2CT10-M5L	329.69	M5 - 0.8	2CT10-M5P	2CT20-M5	130.31
M6 - 1	2CT10-M6F	2CT10-M6F	329.69	M6 - 1	2CT10-M6L	2CT10-M6L	329.69	M6 - 1	2CT10-M6P	2CT20-M6	130.31
M8 - 1.25	2CT10-M8F	2CT10-M8F	377.12	M8 - 1.25	2CT10-M8L	2CT10-M8L	377.12	M8 - 1.25	2CT10-M8P	2CT20-M8	156.38
M10 - 1.5	2CT10-M10F	2CT10-M10F	377.12	M10 - 1.5	2CT10-M10L	2CT10-M10L	377.12	M10 - 1.5	2CT10-M10P	2CT20-M10	156.38
M12 - 1.75	2CT10-M12F	2CT10-M12F	377.12	M12 - 1.75	2CT10-M12L	2CT10-M12L	377.12	M12 - 1.75	2CT10-M12P	2CT20-M12	156.38

Bulk Inserts Free Running - Metric

Only Supplied in Full Bag Quantities



METRIC COARSE		INSTALLED LENGTH			METRIC FINE		PRICE EACH PER INSERT (100/BAG)			
Thread Size	Part No.	inches	mm	D's	Thread Size	Part No.	100+	500+	1000+	5000+
M2 - 0.4	05022	0.079	2.0	1D			0.590	0.422	0.337	0.250
	05023	0.118	3.0	1.5D			0.651	0.465	0.371	0.281
	05024	0.157	4.0	2D			0.689	0.493	0.393	0.292
	05025 ▲	0.197	5.0	2.5D			0.787	0.561	0.449	0.334
	05026 ▲	0.236	6.0	3D			0.983	0.703	0.561	0.417
M2.2 - 0.45	05012	0.087	2.2	1D			0.533	0.382	0.304	0.229
	05013	0.13	3.3	1.5D			0.571	0.408	0.326	0.240
	05014	0.173	4.4	2D			0.590	0.422	0.337	0.250
	05015 ▲	0.217	5.5	2.5D			0.651	0.465	0.371	0.281
	05016 ▲	0.26	6.6	3D			0.708	0.506	0.404	0.302
M2.5 - 0.45	05252	0.098	2.5	1D			0.483	0.345	0.275	0.209
	05253	0.15	3.8	1.5D			0.513	0.367	0.293	0.219
	05254	0.197	5.0	2D			0.540	0.387	0.309	0.229
	05255	0.248	6.3	2.5D			0.579	0.415	0.332	0.250
	05256	0.295	7.5	3D			0.651	0.465	0.371	0.281
M3 - 0.5	05032	0.118	3.0	1D			0.483	0.345	0.275	0.209
	05033	0.177	4.5	1.5D			0.513	0.367	0.293	0.219
	05034	0.236	6.0	2D			0.540	0.387	0.309	0.229
	05035	0.295	7.5	2.5D			0.579	0.415	0.332	0.250
	05036	0.354	9.0	3D			0.651	0.465	0.371	0.281
M3.5 - 0.6	05352	0.138	3.5	1D			0.512	0.366	0.292	0.219
	05353	0.209	5.3	1.5D			0.551	0.393	0.315	0.240
	05354	0.276	7.0	2D			0.590	0.422	0.337	0.250
	05355 ▲	0.346	8.8	2.5D			0.651	0.465	0.371	0.281
	05356 ▲	0.413	10.5	3D			0.708	0.506	0.404	0.302
M4 - 0.7	05042	0.157	4.0	1D			0.483	0.345	0.275	0.209
	05043	0.236	6.0	1.5D			0.513	0.367	0.293	0.219
	05044	0.315	8.0	2D			0.540	0.387	0.309	0.229
	05045	0.394	10.0	2.5D			0.579	0.415	0.332	0.250
	05046	0.472	12.0	3D			0.651	0.465	0.371	0.281
M5 - 0.8	05052	0.197	5.0	1D			0.483	0.345	0.275	0.209
	05053	0.295	7.5	1.5D			0.513	0.367	0.293	0.219
	05054	0.394	10.0	2D			0.540	0.387	0.309	0.229
	05055	0.492	12.5	2.5D			0.611	0.437	0.349	0.261
	05056	0.591	15.0	3D			0.689	0.493	0.393	0.292
M6 - 1	05062	0.236	6.0	1D			0.529	0.376	0.301	0.229
	05063	0.354	9.0	1.5D			0.579	0.415	0.332	0.250
	05064	0.472	12.0	2D			0.611	0.437	0.349	0.261
	05065	0.591	15.0	2.5D			0.662	0.473	0.378	0.281
	05066	0.709	18.0	3D			0.725	0.518	0.415	0.313
M7 - 1	05072	0.276	7.0	1D			0.540	0.387	0.309	0.229
	05073	0.413	10.5	1.5D			0.634	0.453	0.362	0.271
	05074	0.551	14.0	2D			0.697	0.499	0.399	0.302
	05075	0.689	17.5	2.5D			0.867	0.620	0.495	0.375
	05076	0.827	21.0	3D			1.034	0.739	0.591	0.448
M8 - 1.25	05082	0.945	24.0	1D	M8 - 1	07082	0.559	0.400	0.319	0.240
	05083	0.472	12.0	1.5D		07083	0.634	0.453	0.362	0.271
	05084	0.63	16.0	2D		07084	0.697	0.499	0.399	0.302
	05085	0.787	20.0	2.5D		07085	0.867	0.620	0.495	0.375
	05086	0.945	24.0	3D		07086	1.034	0.739	0.591	0.448

▲ Denotes non-popular parts - Price On Application. Minimum quantities and order values may apply.
 Only supplied in full bag quantities.
 Dry film lubing and plating available.

Australian Price List Effective July 2013
 All prices are exclusive of GST

Bulk Inserts Free Running - Metric

Only Supplied in Full Bag Quantities



METRIC COARSE		INSTALLED LENGTH			METRIC FINE		PRICE EACH PER INSERT (100/BAG)			
Thread Size	Part No.	inches	mm	D's	Thread Size	Part No.	100+	500+	1000+	5000+
		0.315	8.0	1D	M8 - 0.75	08082 ▲	0.787	0.561	0.449	0.334
		0.394	10.0	1.25D		08083 ▲	0.890	0.637	0.509	0.386
		0.472	12.0	1.5D		08084 ▲	1.014	0.725	0.579	0.438
		0.63	16.0	2D						
		0.787	20.0	2.5D						
M9 - 1.25	05092	0.354	9.0	1D	M9 - 1	07092	0.787	0.561	0.449	0.334
	05093	0.531	13.5	1.5D		07093	0.890	0.637	0.509	0.386
	05094	0.709	18.0	2D		07094 ▲	1.014	0.725	0.579	0.438
	05095 ▲	0.886	22.5	2.5D		07095 ▲	1.221	0.873	0.697	0.521
	05096 ▲	1.063	27.0	3D		07096 ▲	1.449	1.034	0.828	0.626
M10 - 1.5	05102	0.394	10.0	1D	M10 - 1.25	07102	0.787	0.561	0.449	0.334
	05103	0.591	15.0	1.5D		07103	0.890	0.637	0.509	0.386
	05104	0.787	20.0	2D		07104	1.014	0.725	0.579	0.438
	05105	0.984	25.0	2.5D		07105	1.221	0.873	0.697	0.521
	05106	1.181	30.0	3D		07106	1.449	1.034	0.828	0.626
		0.394	10.0	1D	M10 - 1	08102	0.787	0.561	0.449	0.334
		0.591	15.0	1.5D		08103	0.890	0.637	0.509	0.386
		0.787	20.0	2D		08104	1.014	0.725	0.579	0.438
		0.984	25.0	2.5D		08105	1.221	0.873	0.697	0.521
		1.181	30.0	3D		08106	1.449	1.034	0.828	0.626
M11 - 1.5	05112	0.433	11.0	1D	M11 - 1.25	07112	1.149	0.821	0.657	0.490
	05113	0.650	16.5	1.5D		07113	1.242	0.887	0.710	0.532
	05114	0.866	22.0	2D		07114	1.449	1.034	0.828	0.626
	05115	1.083	27.5	2.5D		07115 ▲	1.862	1.330	1.064	0.803
	05116	1.299	33.0	3D		07116 ▲	2.069	1.478	1.182	0.886
		0.433	11.0	1D	M11 - 1	08112	1.149	0.821	0.657	0.490
		0.650	16.5	1.5D		08113	1.242	0.887	0.710	0.532
		0.866	22.0	2D		08114	1.449	1.034	0.828	0.626
		1.083	27.5	2.5D		08115 ▲	1.862	1.330	1.064	0.803
		1.299	33.0	3D		08116 ▲	2.069	1.478	1.182	0.886
M12 - 1.75	05122	0.472	12.0	1D	M12 - 1.5	07122	1.149	0.821	0.657	0.490
	05120-15	0.591	15.0	1.25D			1.242	0.887	0.710	0.532
	05123	0.709	18.0	1.5D		07123	1.242	0.887	0.710	0.532
	05124	0.945	24.0	2D		07124	1.449	1.034	0.828	0.626
	05125	1.181	30.0	2.5D		07125	1.862	1.330	1.064	0.803
	05126	1.417	36.0	3D		07126	2.069	1.478	1.182	0.886
		0.472	12.0	1D	M12 - 1.25	08122	1.149	0.821	0.657	0.490
		0.709	18.0	1.5D		08123	1.242	0.887	0.710	0.532
		0.945	24.0	2D		08124	1.449	1.034	0.828	0.626
		1.181	30.0	2.5D		08125 ▲	1.862	1.330	1.064	0.803
		1.417	36.0	3D		08126 ▲	2.069	1.478	1.182	0.886
		0.472	12.0	1D	M12 - 1	08122-1.0 ▲	1.608	1.149	0.918	0.688
		0.709	18.0	1.5D		08123-1.0	1.738	1.242	0.994	0.740
		0.945	24.0	2D		08124-1.0 ▲	2.028	1.449	1.159	0.865
		1.181	30.0	2.5D		08125-1.0 ▲	2.607	1.862	1.490	1.115
		1.417	36.0	3D		08126-1.0 ▲	2.897	2.069	1.655	1.241

▲ Denotes non-popular parts - Price On Application. Minimum quantities and order values may apply.
 Only supplied in full bag quantities.
 Dry film lubing and plating available.

Bulk Inserts Free Running - Metric

Only Supplied in Full Bag Quantities



METRIC COARSE		INSTALLED LENGTH			METRIC FINE		PRICE EACH PER INSERT (50/BAG)			
Thread Size	Part No.	inches	mm	D's	Thread Size	Part No.	50+	250+	500+	1000+
M13 - 1.75		0.512	13.0	1D	M13 - 1.5					
	05133 ▲	0.768	19.5	1.5D		07133 ▲	3.685	2.633	2.106	1.585
		1.024	26	2D						
		1.280	32.5	2.5D						
		1.535	39.0	3D						
		0.512	13.0	1D	M13 - 1.25					
		0.768	19.5	1.5D		08133 ▲	3.685	2.633	2.106	1.585
		1.024	26	2D						
		1.280	32.5	2.5D						
		1.535	39.0	3D						
M14 - 2	05142	0.551	14.0	1D	M14 - 1.5	07142	1.534	1.097	0.877	0.657
	05143	0.827	21.0	1.5D		07143	1.966	1.404	1.124	0.844
	05144	1.102	28.0	2D		07144	2.459	1.756	1.404	1.053
	05145	1.378	35.0	2.5D		07145 ▲	3.047	2.178	1.742	1.303
	05146	1.654	42.0	3D		07146 ▲	3.539	2.528	2.022	1.522
M15 - 2	05152 ▲	0.591	15.0	1D	M15 - 1.5	07152 ▲	1.966	1.404	1.124	0.844
	05153	0.886	22.5	1.5D		07153	2.421	1.730	1.383	1.043
	05154 ▲	1.181	30.0	2D		07154 ▲	3.105	2.216	1.773	1.334
	05155 ▲	1.476	37.5	2.5D		07155 ▲	3.725	2.660	2.129	1.595
	05156 ▲	1.772	45.0	3D		07156 ▲	4.345	3.105	2.483	1.866
M16 - 2	05162	0.63	16.0	1D	M16 - 1.5	07162	1.966	1.404	1.124	0.844
	05160-20▲	0.787	20.0	1.25D			2.421	1.730	1.383	1.043
	05163	0.945	24.0	1.5D		07163	2.421	1.730	1.383	1.043
	05164	1.26	32.0	2D		07164	3.105	2.216	1.773	1.334
	05165	1.575	40.0	2.5D		07165 ▲	3.725	2.660	2.129	1.595
	05166	1.89	48.0	3D		07166 ▲	4.345	3.105	2.483	1.866
M18 - 2.5	05182	0.709	18.0	1D	M18 - 2	07182 ▲	2.814	2.009	1.606	1.209
	05183	1.063	27.0	1.5D		07183	3.311	2.364	1.892	1.418
	05184	1.417	36.0	2D		07184 ▲	4.345	3.105	2.483	1.866
	05185	1.772	45.0	2.5D		07185 ▲	5.380	3.844	3.074	2.304
	05186	2.126	54.0	3D		07186 ▲	6.415	4.582	3.665	2.721
		0.709	18.0	1D	M18 - 1.5	08182	2.814	2.009	1.606	1.209
		1.063	27.0	1.5D		08183	3.311	2.364	1.892	1.418
		1.417	36.0	2D		08184	4.345	3.105	2.483	1.866
		1.772	45.0	2.5D		08185	5.380	3.844	3.074	2.304
		2.126	54.0	3D		08186 ▲	6.415	4.582	3.665	2.752

METRIC COARSE		INSTALLED LENGTH			METRIC FINE		PRICE EACH PER INSERT (25/BAG)			
Thread Size	Part No.	inches	mm	D's	Thread Size	Part No.	25+	125+	250+	500+
M20 - 2.5	05202	0.787	20.0	1D	M20 - 2	07202 ▲	3.931	2.807	2.247	1.689
	05200-25 ▲	0.984	25.0	1.25D			4.553	3.253	2.601	1.952
	05203	1.181	30.0	1.5D		07203	4.553	3.253	2.601	1.949
	05204	1.575	40.0	2D		07204	5.173	3.696	2.957	2.221
	05205	1.969	50.0	2.5D		07205 ▲	5.702	4.072	3.258	2.439
	05206	2.362	60.0	3D		07206 ▲	6.685	4.775	3.819	2.867
		0.787	20.0	1D	M20 - 1.5	08202	3.931	2.807	2.247	1.689
		1.181	30.0	1.5D		08203	4.553	3.253	2.601	1.949
		1.575	40.0	2D		08204	5.173	3.696	2.957	2.221
		1.969	50.0	2.5D		08205 ▲	5.702	4.072	3.258	2.439
		2.362	60.0	3D		08206 ▲	6.685	4.775	3.819	2.867
M22 - 2.5	05222	0.866	22.0	1D	M22 - 2	07222 ▲	4.966	3.548	2.838	2.127
	05223	1.299	33.0	1.5D		07223	5.691	4.066	3.253	2.439
	05224 ▲	1.732	44.0	2D		07224 ▲	6.622	4.730	3.783	2.836
	05225	2.165	55.0	2.5D		07225 ▲	7.767	5.547	4.438	3.326
	05226 ▲	2.598	66.0	3D		07226 ▲	9.043	6.459	5.168	3.878

Bulk Inserts Free Running - Metric

Only Supplied in Full Bag Quantities



METRIC COARSE		INSTALLED LENGTH			METRIC FINE		PRICE EACH PER INSERT (25/BAG)			
Thread Size	Part No.	inches	mm	D's	Thread Size	Part No.	25+	125+	250+	500+
		0.866	22.0	1D	M22 - 1.5	08222	4.966	3.548	2.838	2.127
		1.299	33.0	1.5D		08223	5.691	4.066	3.253	2.439
		1.732	44.0	2D		08224	6.622	4.730	3.783	2.836
		2.165	55.0	2.5D		08225	7.767	5.547	4.438	3.326
		2.598	66.0	3D		08226 ▲	9.043	6.459	5.168	3.878
M24 - 3	05242	0.945	24.0	1D	M24 - 2	07242 ▲	6.208	4.435	3.548	2.658
	05243	1.417	36.0	1.5D		07243	7.036	5.026	4.020	3.013
	05244	1.89	48.0	2D		07244 ▲	8.070	5.764	4.611	3.461
	05245	2.362	60.0	2.5D		07245 ▲	9.725	6.946	5.558	4.170
	05246	2.835	72.0	3D		07246 ▲	10.966	7.833	6.266	4.702
		0.945	24.0	1D	M24 - 1.5	08242	6.208	4.435	3.548	2.658
		1.417	36.0	1.5D		08243	7.036	5.026	4.020	3.013
		1.89	48.0	2D		08244	8.070	5.764	4.611	3.461
		2.362	60.0	2.5D		08245 ▲	9.725	6.946	5.558	4.170
		2.835	72.0	3D		08246 ▲	10.966	7.833	6.266	4.702
		1.024	26.0	1D	M26 - 1.5	08262	9.043	6.459	5.168	3.878
		1.535	39.0	1.5D		08263	10.615	7.583	6.065	4.545
		2.047	52.0	2D		08264 ▲	12.384	8.847	7.076	5.306
		2.559	65.0	2.5D		08265 ▲	14.484	10.347	8.276	6.213
		3.071	78.0	3D		08266 ▲	16.554	11.824	9.460	7.099

METRIC COARSE		INSTALLED LENGTH			METRIC FINE		PRICE EACH PER INSERT (10/BAG)			
Thread Size	Part No.	inches	mm	D's	Thread Size	Part No.	10+	50+	100+	500+
M27 - 3	05272 ▲	1.063	27.0	1D	M27 - 2	07272 ▲	9.043	6.459	5.168	3.878
	05273	1.594	40.5	1.5D		07273	10.615	7.583	6.065	4.545
	05274	2.126	54.0	2D		07274	12.384	8.847	7.076	5.306
	05275 ▲	2.657	67.5	2.5D		07275 ▲	14.484	10.347	8.276	6.213
	05276 ▲	3.189	81.0	3D		07276 ▲	16.554	11.824	9.460	7.099
		1.063	27.0	1D	M27 - 1.5	08272 ▲	9.043	6.459	5.168	3.878
		1.594	40.5	1.5D		08273 ▲	10.615	7.583	6.065	4.545
		2.126	54.0	2D		08274 ▲	12.384	8.847	7.076	5.306
		2.657	67.5	2.5D		08275 ▲	14.484	10.347	8.276	6.213
		3.189	81.0	3D		08276 ▲	16.554	11.824	9.460	7.099
M30 - 3.5	05302	1.181	30.0	1D	M30 - 2	07302 ▲	9.830	7.021	5.617	4.212
	05300-37.5	1.476	37.5	1.25D			11.794	8.424	6.740	5.056
	05303	1.772	45.0	1.5D		07303	11.794	8.424	6.740	5.056
	05304	2.362	60.0	2D		07304 ▲	13.957	9.969	7.975	5.984
	05305 ▲	2.953	75.0	2.5D		07305 ▲	16.554	11.824	9.460	7.099
		3.543	90.0	3D	07306 ▲	18.623	13.302	10.642	7.986	
M30 - 3	05302-3 ▲	1.181	30.0	1D	M30 - 1.5	08302	9.830	7.021	5.617	4.212
	05303-3	1.772	45.0	1.5D		08303 ▲	11.794	8.424	6.740	5.056
	05304-3 ▲	2.362	60.0	2D		08304 ▲	13.957	9.969	7.975	5.984
	05305-3 ▲	2.953	75.0	2.5D		08305 ▲	16.554	11.824	9.460	7.099
	05306-3 ▲	3.543	90.0	3D		08306 ▲	18.623	13.302	10.642	7.986
M33 - 3.5	05332 ▲	1.299	33.0	1D	M33 - 2	07332 ▲	10.812	7.723	6.178	4.639
	05333	1.949	49.5	1.5D		07333 ▲	13.449	9.608	7.685	5.765
	05334 ▲	2.598	66.0	2D		07334 ▲	16.554	11.824	9.460	7.099
	05335 ▲	3.248	82.5	2.5D		07335 ▲	18.623	13.302	10.642	7.986
	05336 ▲	3.898	99.0	3D		07336 ▲	22.762	16.259	13.006	9.758
		1.299	33.00	1D	M33 - 3	07332-3 ▲	10.812	7.723	6.178	4.639
		1.949	49.50	1.5D		07333-3 ▲	13.449	9.608	7.685	5.765
		2.598	66.00	2D		07334-3 ▲	16.554	11.824	9.460	7.099

▲ Denotes non-popular parts - Price On Application. Minimum quantities and order values may apply.
 Only supplied in full bag quantities.
 Dry film lubing and plating available.

Bulk Inserts Free Running - Metric

Only Supplied in Full Bag Quantities



METRIC COARSE		INSTALLED LENGTH			METRIC FINE		PRICE EACH PER INSERT (10/BAG)			
Thread Size	Part No.	inches	mm	D's	Thread Size	Part No.	10+	50+	100+	500+
M36 - 4.0	05362	1.417	36.0	1D	M36 - 3	07362	12.415	8.869	7.094	5.317
	05363	2.126	54.0	1.5D		07363	14.484	10.347	8.276	6.213
	05364	2.835	72.0	2D		07364	18.623	13.302	10.642	7.986
	05365 ▲	3.543	90.0	2.5D		07365 ▲	22.762	16.259	13.006	9.758
	05366 ▲	4.252	108.0	3D		07366 ▲	26.901	19.214	15.372	11.530
		1.417	36.0	1D	M36 - 1.5	08362 ▲	12.415	8.869	7.094	5.317
		2.126	54.0	1.5D		08363 ▲	14.484	10.347	8.276	6.213
		2.835	72.0	2D		08364 ▲	18.623	13.302	10.642	7.986
		3.543	90.0	2.5D		08365 ▲	22.762	16.259	13.006	9.758
		4.252	108.0	3D		08366 ▲	26.901	19.214	15.372	11.530
		1.417	36.0	1D	M36 - 2	07362-2 ▲	POA	POA	POA	POA
		2.126	54.0	1.5D		07363-2 ▲	POA	POA	POA	POA
		2.835	72.0	2D		07364-2 ▲	POA	POA	POA	POA
		3.543	90.0	2.5D		07365-2 ▲	POA	POA	POA	POA
		4.252	108.0	3D		07366-2 ▲	POA	POA	POA	POA
M39 - 4	05392	1.535	39.0	1D	M39 - 3	07392 ▲	13.449	9.608	7.685	5.765
	05393	2.303	58.5	1.5D		07393	16.554	11.824	9.460	7.099
	05394	3.071	78.0	2D		07394 ▲	20.693	14.781	11.824	8.872
	05395 ▲	3.839	97.5	2.5D		07395 ▲	26.901	19.214	15.372	11.530
	05396 ▲	4.606	117.0	3D		07396 ▲	33.108	23.648	18.918	14.188
		1.535	39.0	1D	M39 - 2	08392 ▲	13.449	9.608	7.685	5.765
		2.303	58.5	1.5D		08393	16.554	11.824	9.460	7.099
		3.071	78.0	2D		08394 ▲	20.693	14.781	11.824	8.872
		3.839	97.5	2.5D		08395 ▲	26.901	19.214	15.372	11.530
		4.606	117.0	3D		08396 ▲	33.108	23.648	18.918	14.188
M42 - 4.5	05422 ▲	1.654	42.0	1D	M42 - 3	07422	20.693	14.781	11.824	8.872
	05423	2.480	63.0	1.5D		07423 ▲	26.901	19.214	15.372	11.530
	05424 ▲	3.307	84.0	2D		07424 ▲	33.108	23.648	18.918	14.188
M42 - 4	05422-4 ▲	1.654	42.0	1D	M42 - 2	08422 ▲	20.693	14.781	11.824	8.872
	05423-4	2.480	63.0	1.5D		08423 ▲	26.901	19.214	15.372	11.530
	05424-4	3.307	84.0	2D		08424 ▲	33.108	23.648	18.918	14.188
M45 - 4.5	05453 ▲	2.657	67.5	1.5D	M45 - 3	07453	33.417	23.870	19.097	14.324
M48 - 5	05483	2.835	72.0	1.5D	M48 - 3	07483	39.316	28.083	22.466	16.847
M48 - 4	05483-4 ▲	2.835	72.0	1.5D			41.281	29.487	23.590	17.691
M52 - 5	05523 ▲	3.071	78.0	1.5D	M52 - 3	07523 ▲	43.246	30.890	24.712	18.536

▲ Denotes non-popular parts - Price On Application. Minimum quantities and order values may apply.

Only supplied in full bag quantities.

Dry film lubing and plating available.

Bulk Inserts Free Running - Metric - Sparkplug and Lefthand Thread

Only Supplied in Full Bag Quantities

SPARKPLUG		INSTALLED LENGTH			PRICE EACH PER INSERT (100/BAG)			
Thread Size	Part No.	inch	mm	D's	100+	500+	1000+	5000+
M10 - 1	08108	0.339	8.6		0.804	0.561	0.449	0.365
	08109	0.500	12.7		0.909	0.637	0.509	0.407
M12 - 1.25	08122	0.500	12.7	1D	1.149	0.821	0.657	0.490
	08123	0.750	19.1	1.5D	1.242	0.887	0.710	0.532
M14 - 1.25	08148	0.375	9.5		0.686	0.480	0.385	0.313
	08141	0.472	12.0		0.877	0.613	0.491	0.396
	08147	0.438	11.1		0.877	0.613	0.491	0.396
	08149	0.500	12.7		1.046	0.732	0.586	0.469
	08140	0.750	19.1		1.373	0.961	0.769	0.615
	08140-8.4 ▲	0.331	8.4		0.697	0.489	0.390	0.313
	08140-12.4 ▲	0.488	12.4		1.078	0.755	0.604	0.480
	08140-16.4 ▲	0.646	16.4		1.478	1.034	0.828	0.667
M18 - 1.5	08189	0.500	12.7		1.942	1.360	1.087	0.876
M18 - 1.5 (Inconel)	08181XUP	0.500	12.5		3.512	2.459	1.966	1.574

METRIC LEFTHAND THREAD		INSTALLED LENGTH			PRICE EACH PER INSERT (100/BAG)			
Thread Size	Part No.	inch	mm	D's	100+	500+	1000+	5000+
M6 - 1	05063LH ▲	0.354	9.0	1.5D	1.182	0.826	0.662	0.500
M8 - 1.25	05083LH ▲	0.472	12.0	1.5D	1.331	0.932	0.744	0.553
M10 - 1.5	05103LH ▲	0.591	15.0	1.5D	1.858	1.301	1.041	0.782
M12 - 1.75	05123LH ▲	0.709	18.0	1.5D	2.534	1.773	1.419	1.063

BICYCLE		INSTALLED LENGTH			PRICE EACH PER INSERT (100/BAG)			
Thread Size	Part No.	inch	mm	D's	100+	500+	1000+	5000+
M10 - 1 x 6.8	08100-6.8 ▲	0.256	6.8		0.828	0.591		

▲ Denotes non-popular parts - Price On Application. Minimum quantities and order values may apply.

Only supplied in full bag quantities.

Dry film lubing and plating available.

Bulk Inserts Free Running - UNC/UNF

Only Supplied in Full Bag Quantities



UNC Thread Size	Part No.	INSTALLED LENGTH			UNF Thread Size	Part No.	PRICE EACH PER INSERT (100/BAG)			
		inches	mm	D's			100+	500+	1000+	5000+
#2 - 56	03522	0.086	2.2	1D			0.621	0.443	0.354	0.271
	03523	0.129	3.3	1.5D			0.673	0.481	0.385	0.292
	03524	0.172	4.4	2D			0.704	0.502	0.402	0.302
	03525	0.215	5.5	2.5D			0.744	0.533	0.425	0.323
	03526	0.258	6.6	3D			0.817	0.585	0.467	0.354
#3 - 48	03532	0.099	2.5	1D	#3 - 56	04532 ▲	1.034	0.739	0.591	0.448
	03533	0.149	3.8	1.5D		04533	1.118	0.798	0.639	0.480
	03534 ▲	0.198	5.0	2D		04534 ▲	1.180	0.843	0.674	0.511
	03535 ▲	0.248	6.3	2.5D		04535 ▲	1.242	0.887	0.710	0.532
	03536 ▲	0.297	7.5	3D		04536 ▲	1.366	0.976	0.780	0.584
#4 - 40	03542	0.112	2.8	1D	#4 - 48	04542 ▲	0.476	0.340	0.272	0.209
	03543	0.168	4.3	1.5D		04543	0.508	0.363	0.290	0.219
	03544	0.224	5.7	2D		04544	0.538	0.385	0.308	0.229
	03545	0.280	7.1	2.5D		04545 ▲	0.579	0.415	0.332	0.250
	03546	0.336	8.5	3D		04546	0.621	0.443	0.354	0.271
#5 - 40	03552	0.112	2.8	1D			0.476	0.340	0.272	0.209
	03553	0.168	4.3	1.5D			0.508	0.363	0.290	0.219
	03554	0.224	5.7	2D			0.538	0.385	0.308	0.229
	03555 ▲	0.280	7.1	2.5D			0.579	0.415	0.332	0.250
	03556 ▲	0.336	8.5	3D			0.621	0.443	0.354	0.271
#6 - 32	03562	0.138	3.5	1D	#6 - 40	04562 ▲	0.476	0.340	0.272	0.209
	03563	0.207	5.3	1.5D		04563	0.508	0.363	0.290	0.219
	03564	0.276	7	2D		04564 ▲	0.538	0.385	0.308	0.229
	03565	0.345	8.8	2.5D		04565 ▲	0.579	0.415	0.332	0.250
	03566	0.414	10.5	3D		04566 ▲	0.621	0.443	0.354	0.271
#8 - 32	03582	0.164	4.2	1D	#8 - 36	04582 ▲	0.476	0.340	0.272	0.209
	03583	0.246	6.2	1.5D		04583	0.508	0.363	0.290	0.219
	03584	0.328	8.3	2D		04584 ▲	0.538	0.385	0.308	0.229
	03585	0.410	10.4	2.5D		04585 ▲	0.579	0.415	0.332	0.250
	03586	0.492	12.5	3D		04586 ▲	0.621	0.443	0.354	0.271
#10 - 24	03602	0.190	4.8	1D	#10 - 32	04602	0.476	0.340	0.272	0.209
	03603	0.285	7.2	1.5D		04603	0.508	0.363	0.290	0.219
	03604	0.380	9.7	2D		04604	0.538	0.385	0.308	0.229
	03605	0.475	12.1	2.5D		04605	0.579	0.415	0.332	0.250
	03606	0.570	14.5	3D		04606	0.621	0.443	0.354	0.271
#12 - 24	03622 ▲	0.216	5.5	1D	#12 - 28	04622 ▲	0.548	0.392	0.314	0.240
	03623	0.324	8.2	1.5D		04623	0.570	0.407	0.325	0.240
	03624	0.432	11	2D		04624	0.642	0.459	0.367	0.271
	03625 ▲	0.540	13.7	2.5D		04625 ▲	0.683	0.489	0.390	0.292
	03626 ▲	0.648	16.5	3D		04626 ▲	0.744	0.533	0.425	0.323
1/4 - 20	03042	0.250	6.4	1D	1/4 - 28	04042	0.548	0.392	0.314	0.240
	03043	0.375	9.5	1.5D		04043	0.570	0.407	0.325	0.240
	03044	0.500	12.7	2D		04044	0.642	0.459	0.367	0.271
	03045	0.625	15.9	2.5D		04045	0.683	0.489	0.390	0.292
	03046	0.750	19.1	3D		04046	0.744	0.533	0.425	0.323
5/16 - 18	03052	0.313	8	1D	5/16 - 24	04052	0.602	0.428	0.343	0.261
	03053	0.470	11.9	1.5D		04053	0.631	0.452	0.361	0.271
	03054	0.626	15.9	2D		04054	0.694	0.495	0.395	0.302
	03055	0.783	19.9	2.5D		04055	0.787	0.561	0.449	0.334
	03056	0.939	23.9	3D		04056	0.890	0.637	0.509	0.386
3/8 - 16	03062	0.375	9.5	1D	3/8 - 24	04062	0.808	0.577	0.461	0.344
	03063	0.563	14.3	1.5D		04063	0.890	0.637	0.509	0.386
	03064	0.750	19.1	2D		04064	1.034	0.739	0.591	0.448
	03065	0.938	23.8	2.5D		04065	1.180	0.843	0.674	0.511
	03066	1.125	28.6	3D		04066	1.346	0.961	0.769	0.573
7/16 - 14	03072	0.438	11.1	1D	7/16 - 20	04072	0.994	0.710	0.568	0.427
	03073	0.657	16.7	1.5D		04073	1.056	0.755	0.604	0.459
	03074	0.876	22.3	2D		04074	1.180	0.843	0.674	0.511
	03075	1.095	27.8	2.5D		04075	1.449	1.034	0.828	0.626
	03076	1.314	33.4	3D		04076 ▲	1.655	1.182	0.946	0.709

Australian Price List Effective July 2013
All prices are exclusive of GST

▲ Denotes non-popular parts - Price On Application. Minimum quantities and order values may apply.
Dry film lubing and plating available.

Bulk Inserts Free Running - UNC/UNF

Only Supplied in Full Bag Quantities



UNC		INSTALLED LENGTH			UNF		PRICE EACH PER INSERT (100/BAG)			
Thread Size	Part No.	inches	mm	D's	Thread Size	Part No.	100+	500+	1000+	5000+
1/2 - 13	03082	0.500	12.7	1D	1/2 - 20	04082	1.138	0.813	0.651	0.490
	03083	0.750	19.1	1.5D		04083	1.211	0.865	0.692	0.521
	03084	1.000	25.4	2D		04084	1.366	0.976	0.780	0.584
	03085	1.250	31.8	2.5D		04085	1.655	1.182	0.946	0.709
	03086	1.500	38.1	3D		04086	1.966	1.404	1.124	0.844

UNC		INSTALLED LENGTH			UNF		PRICE EACH PER INSERT (50/BAG)			
Thread Size	Part No.	inches	mm	D's	Thread Size	Part No.	50+	100+	500+	1000+
9/16 - 12	03092	0.563	14.3	1D	9/16 - 18	04092	1.449	1.034	0.828	0.626
	03093	0.845	21.5	1.5D		04093	1.655	1.182	0.946	0.709
	03094	1.126	28.6	2D		04094	2.380	1.700	1.360	1.022
	03095	1.408	35.8	2.5D		04095 ▲	3.001	2.143	1.715	1.282
	03096 ▲	1.689	42.9	3D		04096 ▲	3.622	2.586	2.069	1.553
5/8 - 11	03102	0.625	15.9	1D	5/8 - 18	04102	1.945	1.389	1.111	0.834
	03103	0.938	23.8	1.5D		04103	2.380	1.700	1.360	1.022
	03104	1.250	31.8	2D		04104	3.021	2.158	1.726	1.293
	03105	1.563	39.7	2.5D		04105 ▲	3.642	2.601	2.081	1.564
	03106	1.875	47.6	3D		04106 ▲	4.345	3.105	2.483	1.866
11/16 - 11	03112 ▲	0.688	17.5	1D	3/4 - 16	04122	2.794	1.995	1.597	1.199
	03113	1.032	26.2	1.5D		04123	3.301	2.358	1.886	1.418
	03114 ▲	1.376	35	2D		04124	4.345	3.105	2.483	1.866
	03115	1.720	43.7	2.5D		04125	5.298	3.783	3.026	2.273
	03116	2.064	52.4	3D		04126 ▲	6.208	4.435	3.548	2.658

UNC		INSTALLED LENGTH			UNF		PRICE EACH PER INSERT (25/BAG)			
Thread Size	Part No.	inches	mm	D's	Thread Size	Part No.	25+	125+	250+	500+
7/8 - 9	03142	0.875	22.2	1D	7/8 - 14	04142	4.759	3.400	2.720	2.043
	03143	1.313	33.3	1.5D		04143	5.587	3.991	3.192	2.398
	03144	1.750	44.5	2D		04144 ▲	6.415	4.582	3.665	2.752
	03145 ▲	2.188	55.6	2.5D		04145 ▲	7.242	5.173	4.139	3.107
	03146	2.625	66.7	3D		04146 ▲	8.276	5.912	4.730	3.545
1" - 8	03162	1.000	25.4	1D	1" - 12	04162	6.104	4.361	3.488	2.617
	03163	1.500	38.1	1.5D		04163	7.036	5.026	4.020	3.013
	03164	2.000	50.8	2D		04164 ▲	8.070	5.764	4.611	3.461
	03165 ▲	2.500	63.5	2.5D		04165 ▲	9.519	6.799	5.439	4.076
	03166 ▲	3.000	76.2	3D		04166 ▲	10.760	7.685	6.149	4.608
		1.000	25.4	1D	1" - 14	04162-14	6.104	4.361	3.488	2.617
		1.500	38.1	1.5D		04163-14	7.036	5.026	4.020	3.013
		2.000	50.8	2D		04164-14	8.070	5.764	4.611	3.461
		2.500	63.5	2.5D		04165-14▲	9.519	6.799	5.439	4.076
		3.000	76.2	3D		04166-14▲	10.760	7.685	6.149	4.608

UNC		INSTALLED LENGTH			UNF		PRICE EACH PER INSERT (10/BAG)			
Thread Size	Part No.	inches	mm	D's	Thread Size	Part No.	10+	50+	100+	500+
1 1/8 - 7	03182	1.125	28.6	1D	1 1/8 - 12	04182	9.830	7.021	5.617	4.212
	03183 ▲	1.688	42.9	1.5D		04183	10.347	7.390	5.912	4.431
	03184 ▲	2.250	57.2	2D		04184 ▲	13.761	9.830	7.864	5.901
	03185 ▲	2.813	71.4	2.5D		04185 ▲	15.726	11.233	8.986	6.745
	03186 ▲	3.375	85.7	3D		04186 ▲	17.692	12.637	10.110	7.579
1 1/4 - 7	03202	1.250	31.8	1D	1 1/4 - 12	04202	10.812	7.723	6.178	4.639
	03203	1.875	47.6	1.5D		04203	11.794	8.424	6.740	5.056
	03204	2.500	63.5	2D		04204 ▲	14.744	10.531	8.424	6.318
	03205 ▲	3.125	79.4	2.5D		04205 ▲	17.692	12.637	10.110	7.579
	03206 ▲	3.750	95.3	3D		04206 ▲	19.657	14.040	11.233	8.423

Australian Price List Effective July 2013
All prices are exclusive of GST

▲ Denotes non-popular parts - Price On Application. Minimum quantities and order values may apply.
Dry film lubing and plating available.

Bulk Inserts Free Running - UNC/UNF

Only Supplied in Full Bag Quantities



UNC		INSTALLED LENGTH			UNF		PRICE EACH PER INSERT (10/BAG)			
Thread Size	Part No.	inches	mm	D's	Thread Size	Part No.	10+	50+	100+	500+
1 3/8 - 6	03222 ▲	1.375	34.9	1D	1 3/8 - 12	04222 ▲	11.794	8.424	6.740	5.056
	03223	2.063	52.4	1.5D		04223	12.415	8.869	7.094	5.317
	03224 ▲	2.750	69.9	2D		04224 ▲	17.692	12.637	10.110	7.579
	03225 ▲	3.438	87.3	2.5D		04225 ▲	21.624	15.446	12.357	9.268
	03226 ▲	4.125	104.8	3D		04226 ▲	23.590	16.850	13.480	10.112
1 1/2 - 6	03242	1.500	38.1	1D	1 1/2 - 12	04242	13.761	9.830	7.864	5.901
	03243	2.250	57.2	1.5D		04243	16.554	11.824	9.460	7.099
	03244 ▲	3.000	76.2	2D		04244 ▲	21.624	15.446	12.357	9.268
	03245 ▲	3.750	95.3	2.5D		04245 ▲	27.520	19.657	15.726	11.791
	03246 ▲	4.500	114.3	3D		04246 ▲	31.452	22.466	17.973	13.480

▲ Denotes non-popular parts - Price On Application. Minimum quantities and order values may apply.
 Only supplied in full bag quantities.
 Dry film lubing and plating available.

Bulk Inserts Free Running - BSW/BSF

Only Supplied in Full Bag Quantities



BSW		INSTALLED LENGTH			BSF		PRICE EACH PER INSERT (100/BAG)			
Thread Size	Part No.	inches	mm	D's	Thread Size	Part No.	100+	500+	1000+	5000+
1/8 - 40	02022	0.125	3.2	1D			0.559	0.400	0.319	0.240
	02023	0.188	4.8	1.5D			0.579	0.415	0.332	0.250
	02024	0.250	6.4	2D			0.621	0.443	0.354	0.271
	02025	0.313	7.9	2.5D			0.744	0.533	0.425	0.323
	02026	0.375	9.5	3D			0.828	0.591	0.473	0.354
3/16 - 24	02032	0.188	4.8	1D	3/16 - 32	00032	0.483	0.345	0.275	0.209
	02033	0.281	7.1	1.5D		00033	0.512	0.366	0.292	0.219
	02034	0.376	9.6	2D		00034 ▲	0.540	0.387	0.309	0.229
	02035	0.470	11.9	2.5D		00035 ▲	0.621	0.443	0.354	0.271
	02036	0.564	14.3	3D		00036 ▲	0.704	0.502	0.402	0.302
1/4 - 20	02042	0.250	6.4	1D	1/4 - 26	00042 ▲	0.548	0.392	0.314	0.240
	02043	0.375	9.5	1.5D		00043	0.570	0.407	0.325	0.240
	02044	0.500	12.7	2D		00044	0.642	0.459	0.367	0.271
	02045	0.625	15.9	2.5D		00045 ▲	0.673	0.481	0.385	0.292
	02046	0.750	19.1	3D		00046 ▲	0.766	0.547	0.438	0.334
5/16 - 18	02052	0.313	8	1D	5/16 - 22	00052	0.559	0.400	0.319	0.240
	02053	0.470	11.9	1.5D		00053	0.642	0.459	0.367	0.271
	02054	0.626	15.9	2D		00054	0.766	0.547	0.438	0.334
	02055	0.783	19.9	2.5D		00055 ▲	0.932	0.665	0.533	0.396
	02056	0.939	23.9	3D		00056 ▲	1.034	0.739	0.591	0.448
3/8 - 16	02062	0.375	9.5	1D	3/8 - 20	00062	0.787	0.561	0.449	0.334
	02063	0.563	14.3	1.5D		00063	0.890	0.637	0.509	0.386
	02064	0.750	19.1	2D		00064	1.014	0.725	0.579	0.438
	02065	0.938	23.8	2.5D		00065 ▲	1.242	0.887	0.710	0.532
	02066	1.125	28.6	3D		00066 ▲	1.449	1.034	0.828	0.626
7/16 - 14	02072	0.438	11.1	1D	7/16 - 18	00072 ▲	0.974	0.695	0.556	0.417
	02073	0.657	16.7	1.5D		00073	1.056	0.755	0.604	0.459
	02074	0.876	22.3	2D		00074 ▲	1.159	0.828	0.662	0.500
	02075	1.095	27.8	2.5D		00075 ▲	1.346	0.961	0.769	0.573
	02076	1.314	33.4	3D		00076 ▲	1.655	1.182	0.946	0.709
1/2 - 12	02082	0.500	12.7	1D	1/2 - 16	00082	1.149	0.821	0.657	0.490
	02083	0.750	19.1	1.5D		00083	1.221	0.873	0.697	0.521
	02084	1.000	25.4	2D		00084	1.449	1.034	0.828	0.626
	02085	1.250	31.8	2.5D		00085 ▲	1.655	1.182	0.946	0.709
	02086	1.500	38.1	3D		00086 ▲	2.277	1.625	1.301	0.980

BSW		INSTALLED LENGTH			BSF		PRICE EACH PER INSERT (50/BAG)			
Thread Size	Part No.	inches	mm	D's	Thread Size	Part No.	50+	100+	500+	1000+
9/16 - 12	02092	0.563	14.3	1D	9/16 - 16	00092 ▲	1.449	1.034	0.828	0.626
	02093	0.845	21.5	1.5D		00093	1.655	1.182	0.946	0.709
	02094	1.126	28.6	2D		00094 ▲	2.380	1.700	1.360	1.022
	02095	1.408	35.8	2.5D		00095 ▲	3.105	2.216	1.773	1.334
	02096	1.689	42.9	3D		00096 ▲	3.725	2.660	2.129	1.595
5/8 - 11	02102	0.625	15.9	1D	5/8 - 14	00102	1.945	1.389	1.111	0.834
	02103	0.938	23.8	1.5D		00103	2.483	1.773	1.419	1.063
	02104	1.250	31.8	2D		00104	3.105	2.216	1.773	1.334
	02105	1.563	39.7	2.5D		00105 ▲	3.931	2.807	2.247	1.689
	02106	1.875	47.6	3D		00106 ▲	4.759	3.400	2.720	2.043
3/4 - 10	02122	0.750	19.1	1D	3/4 - 12	00122	2.794	1.995	1.597	1.199
	02123	1.125	28.6	1.5D		00123	3.311	2.364	1.892	1.418
	02124	1.500	38.1	2D		00124 ▲	4.345	3.105	2.483	1.866
	02125	1.875	47.6	2.5D		00125 ▲	5.587	3.991	3.192	2.398
	02126	2.250	57.2	3D		00126 ▲	6.622	4.730	3.783	2.836

▲ Denotes non-popular parts - Price On Application. Minimum quantities and order values may apply.
 Only supplied in full bag quantities.
 Dry film lubing and plating available.

Bulk Inserts Free Running - BSW/BSF

Only Supplied in Full Bag Quantities



BSW		INSTALLED LENGTH			BSF		PRICE EACH PER INSERT (25/BAG)			
Thread Size	Part No.	inches	mm	D's	Thread Size	Part No.	25+	125+	250+	500+
7/8 - 9	02142	0.875	22.2	1D	7/8 - 11	00142 ▲	4.759	3.400	2.720	2.043
	02143	1.313	33.3	1.5D		00143 ▲	5.587	3.991	3.192	2.398
	02144	1.750	44.5	2D		00144 ▲	6.415	4.582	3.665	2.752
	02145	2.188	55.6	2.5D		00145 ▲	7.656	5.469	4.375	3.284
	02146	2.625	66.7	3D		00146 ▲	8.691	6.208	4.966	3.722
1" - 8	02162	1.000	25.4	1D	1" - 10	00162 ▲	6.208	4.435	3.548	2.658
	02163	1.500	38.1	1.5D		00163 ▲	7.036	5.026	4.020	3.013
	02164	2.000	50.8	2D		00164 ▲	8.070	5.764	4.611	3.461
	02165	2.500	63.5	2.5D		00165 ▲	9.932	7.094	5.675	4.253
	02166	3.000	76.2	3D		00166 ▲	11.381	8.128	6.503	4.879

▲ Denotes non-popular parts - Price On Application. Minimum quantities and order values may apply.
 Only supplied in full bag quantities.
 Dry film lubing and plating available.

Bulk Inserts Free Running - BA/BSC/BSP/NPT

Only Supplied in Full Bag Quantities



BA		INSTALLED LENGTH				PRICE EACH PER INSERT (100/BAG)			
Thread Size	Part No.	inches	mm	D's	100+	500+	1000+	5000+	
0BA	00502 ▲	0.236	6	1D	0.828	0.591	0.473	0.354	
	00503	0.354	9	1.5D	0.910	0.651	0.520	0.386	
	00504	0.472	12	2D	1.076	0.769	0.614	0.459	
	00505 ▲	0.591	15	2.5D	1.324	0.946	0.757	0.573	
	00506 ▲	0.709	18	3D	1.490	1.064	0.851	0.636	
2BA	00522	0.185	4.7	1D	0.828	0.591	0.473	0.354	
	00523	0.278	7.1	1.5D	0.910	0.651	0.520	0.386	
	00524 ▲	0.370	9.4	2D	1.076	0.769	0.614	0.459	
	00525 ▲	0.463	11.8	2.5D	1.324	0.946	0.757	0.573	
	00526 ▲	0.555	14.1	3D	1.490	1.064	0.851	0.636	
4BA	00542 ▲	0.142	3.6	1D	0.828	0.591	0.473	0.354	
	00543	0.213	5.4	1.5D	0.910	0.651	0.520	0.386	
	00544 ▲	0.283	7.2	2D	1.076	0.769	0.614	0.459	
	00545 ▲	0.354	9	2.5D	1.324	0.946	0.757	0.573	
	00546 ▲	0.425	10.8	3D	1.490	1.064	0.851	0.636	
6BA	00562 ▲	0.110	2.8	1D	0.828	0.591	0.473	0.354	
	00563	0.165	4.2	1.5D	0.910	0.651	0.520	0.386	
	00564	0.220	5.6	2D	1.076	0.769	0.614	0.459	
	00565 ▲	0.276	7	2.5D	1.324	0.946	0.757	0.573	
	00566 ▲	0.331	8.4	3D	1.490	1.064	0.851	0.636	

BSC		INSTALLED LENGTH				PRICE EACH PER INSERT (100/BAG)			
Thread Size	Part No.	inches	mm	D's	100+	500+	1000+	5000+	
5/16 - 26	06502 ▲	0.313	8	1D	0.910	0.651	0.520	0.386	
	06503	0.470	11.9	1.5D	1.027	0.733	0.587	0.438	
	06504 ▲	0.626	15.9	2D	1.490	1.064	0.851	0.636	
3/8 - 26	06602 ▲	0.625	15.9	1D	1.027	0.733	0.587	0.438	
	06603	0.938	23.8	1.5D	1.193	0.851	0.681	0.511	
	06604 ▲	1.250	31.8	2D	1.655	1.182	0.946	0.709	
7/16 - 26	06702 ▲	0.438	11.1	1D	1.193	0.851	0.681	0.511	
	06703 ▲	0.656	16.7	1.5D	1.655	1.182	0.946	0.709	
	06704 ▲	0.876	22.3	2D	2.317	1.655	1.324	0.990	
1/2 - 26	06802 ▲	0.500	12.7	1D	2.186	1.562	1.249	0.990	
	06803	0.750	19.1	1.5D	2.499	1.785	1.428	1.136	
	06804 ▲	2.000	50.8	2D	3.280	2.342	1.874	1.491	

BSP		INSTALLED LENGTH				NPT		PRICE EACH PER INSERT (100/BAG)			
Thread Size	Part No.	inches	mm	D's	Thread Size	Part No.	100+	500+	1000+	5000+	
1/8 - 28	01022	0.125	3.2	1D	1/8 - 27		1.159	0.828	0.662	0.500	
	01023	0.188	4.8	1.5D			1.357	0.970	0.776	0.584	
	01024	0.250	6.4	2D			1.821	1.301	1.041	0.782	
	01025	0.313	7.9	2.5D			2.152	1.537	1.230	0.928	
		0.273	6.9	.273			06023	1.357	0.970	0.776	0.584
1/4 - 19	01042	0.250	6.4	1D	1/4 - 18		1.655	1.182	0.946	0.709	
	01043	0.375	9.5	1.5D			1.987	1.419	1.135	0.855	
	01044	0.500	12.7	2D			2.649	1.892	1.514	1.136	
	01045 ▲	0.625	15.9	2.5D			2.979	2.129	1.702	1.282	
		0.394	10.0	.394			06043	1.987	1.419	1.135	1.136
3/8 - 19	01062	0.375	9.5	1D	3/8 - 18		1.821	1.301	1.041	0.782	
	01063	0.563	14.3	1.5D			2.483	1.773	1.419	1.063	
	01064	0.750	19.1	2D			3.477	2.483	1.987	1.491	
	01065 ▲	0.938	23.8	2.5D			4.139	2.957	2.364	1.772	
		0.407	10.3	.407			06063	2.483	1.773	1.419	1.063

▲ Denotes non-popular parts - Price On Application. Minimum quantities and order values may apply.
 Only supplied in full bag quantities.
 Dry film lubing and plating available.

Australian Price List Effective July 2013
 All prices are exclusive of GST

Bulk Inserts Free Running - BSP/NPT/Special Threads/UN

Only Supplied in Full Bag Quantities

BSP Thread Size	Part No.	INSTALLED LENGTH			NPT Thread Size	Part No.	PRICE EACH PER INSERT (50/BAG)			
		inches	mm	D's			50+	100+	500+	1000+
1/2 - 14	01082	0.500	12.7	1D	1/2 - 14	06083	3.228	2.306	1.844	1.387
	01083	0.750	19.1	1.5D			4.055	2.897	2.317	1.741
	01084 ▲	1.000	25.4	2D			5.298	3.783	3.026	2.273
	01085 ▲	1.250	31.8	2.5D			5.794	4.139	3.311	2.481
		0.534	13.6	.534			4.055	2.897	2.317	1.741
5/8 - 14	01102 ▲	0.625	15.9	1D	3/4 - 14	06123	4.801	3.429	2.743	2.054
	01103 ▲	0.938	23.8	1.5D			5.794	4.139	3.311	2.481
	01104 ▲	1.250	31.8	2D			7.283	5.202	4.162	3.128
3/4 - 14	01122	0.750	19.1	1D	3/4 - 14	06123	4.966	3.548	2.838	2.127
	01123	1.125	28.6	1.5D			5.960	4.257	3.406	2.554
	01124 ▲	1.500	38.1	2D			7.614	5.439	4.351	3.263
		0.553	14.0	.553			5.960	4.257	3.406	2.554

BSP Thread Size	Part No.	INSTALLED LENGTH			NPT Thread Size	Part No.	PRICE EACH PER INSERT (25/BAG)			
		inches	mm	D's			25+	125+	250+	500+
1" - 11	01162	1.000	25.4	1D	1 - 11 1/2	06163	6.208	4.435	3.548	2.658
	01163 ▲	1.500	38.1	1.5D			7.864	5.617	4.493	3.367
	01164 ▲	2.000	50.8	2D			9.600	6.858	5.487	4.118
		0.661	16.8	.661			7.864	5.617	4.493	3.367

SPECIAL THREADS Thread Size	Part No.	INSTALLED LENGTH			Thread Size	Part No.	PRICE EACH PER INSERT (100/BAG)			
		inches	mm	D's			100+	500+	1000+	5000+
1/4 - 32	04042-32	0.25	6.4	1D	1/4 - 24	04042-24	0.642	0.459	0.367	0.271
	04043-32	0.375	9.5	1.5D		04043-24	0.725	0.518	0.415	0.313
HARLEY 7/16 - 16	04073-16	0.657	16.7	1.5D			1.098	0.784	0.627	0.469

SPECIAL THREADS Thread Size	Part No.	INSTALLED LENGTH			Thread Size	Part No.	PRICE EACH PER INSERT (50/BAG)			
		inches	mm	D's			50+	100+	500+	1000+
CUMMINS 11/16 - 16	04110-16-1.25▲	0.86	21.8				4.139	2.957	2.364	1.772
CARBY 7/8 - 20	04140-20-330▲	0.33	8.4				4.759	3.400	2.720	2.043
CARBY 1" - 20	04160-20-325	0.325	8.3				5.759	4.40	3.72	2.432

8 TPI UN Thread Size	Part No.	INSTALLED LENGTH			Thread Size	Part No.	PRICE EACH PER INSERT (10/BAG)			
		inches	mm	D's			10+	50+	100+	500+
1 1/8 - 8	06182 ▲	1.125	28.6	1D	1 1/8 - 8	06182	8.773	6.266	5.013	3.763
	06183 ▲	1.688	42.9	1.5D			10.263	7.331	5.864	4.399
	06184	2.25	57.2	2D			11.753	8.395	6.717	5.035
1 1/4 - 8	06202 ▲	1.25	31.8	1D	1 1/4 - 8	06202	9.932	7.094	5.675	4.253
	06203	1.875	47.6	1.5D			11.587	8.276	6.622	4.962
	06204	2.5	63.5	2D			14.898	10.642	8.513	6.380
1 3/8 - 8	06222 ▲	1.375	34.9	1D	1 3/8 - 8	06222	11.587	8.276	6.622	4.962
	06223 ▲	2.063	52.4	1.5D			12.911	9.223	7.379	5.536
	06224 ▲	2.75	69.9	2D			16.554	11.824	9.460	7.099
1 1/2 - 8	06242	1.5	38.1	1D	1 1/2 - 8	06242	13.243	9.460	7.568	5.671
	06243 ▲	2.25	57.2	1.5D			15.395	10.996	8.798	6.599
	06244 ▲	3	76.2	2D			19.865	14.188	11.351	8.517
1 5/8 - 8	06262 ▲	1.625	41.3	1D	1 5/8 - 8	06262	23.175	16.554	13.243	9.935
	06263 ▲	2.438	61.9	1.5D			25.658	18.327	14.662	10.998
	06264 ▲	3.25	82.6	2D			33.108	23.648	18.918	14.188
1 3/4 - 8	06282 ▲	1.75	44.5	1D	1 3/4 - 8	06282	23.175	16.554	13.243	9.935
	06283 ▲	2.625	66.7	1.5D			28.969	20.693	16.554	12.416
	06284 ▲	3.5	88.9	2D			36.418	26.012	20.810	15.606
1 7/8 - 8	06302 ▲	1.875	47.6	1D	1 7/8 - 8	06302	26.486	18.918	15.135	11.353
	06303 ▲	2.813	71.4	1.5D			33.108	23.648	18.918	14.188
	06304 ▲	3.75	95.3	2D			41.384	29.560	23.648	17.733
2" - 8	06322 ▲	2	50.8	1D	2" - 8	06322	28.141	20.100	16.081	12.062
	06323	3	76.2	1.5D			36.418	26.012	20.810	15.606
	06324 ▲	4	101.6	2D			46.351	33.108	26.486	19.860
2 1/8 - 8	06343 ▲	3.188	81	1.5D			52.972	37.836	30.270	22.706

Bulk Inserts Free Running - UN/UNC LHT/Bicycle Threads

Only Supplied in Full Bag Quantities



8 TPI UN		INSTALLED LENGTH				PRICE EACH PER INSERT (10/BAG)			
Thread Size	Part No.	inches	mm	D's	10+	50+	100+	500+	
2 1/4 - 8	06362 ▲	2.25	57.2	1D	57.938	41.384	33.108	24.832	
	06363 ▲	3.375	85.7	1.5D	66.214	47.296	37.836	28.377	
	06402 ▲	2.5	63.5	1D	66.214	47.296	37.836	28.377	
2 1/2 - 8	06403 ▲	3.75	95.3	1.5D	74.492	53.208	42.566	31.921	
2 3/4 - 8	06443 ▲	2.75	69.9	1.5D	82.768	59.120	47.296	35.476	
3" - 8	06482 ▲	3	76.2	1D	91.045	65.032	52.026	39.021	
	06483 ▲	4.5	114.3	1.5D	99.322	70.944	56.756	42.565	

UNC LEFT HAND THREAD		INSTALLED LENGTH				PRICE EACH PER INSERT (100/BAG)			
Thread Size	Part No.	inches	mm	D's	100+	500+	1000+	5000+	
1/4 - 20	03043LH	0.25	6.4	1.5D	1.655	1.182	0.946	0.709	
5/16 - 18	03053LH	0.313	8	1.5D	1.655	1.182	0.946	0.709	
3/8 - 16	03063LH	0.375	9.5	1.5D	1.862	1.330	1.064	0.803	
7/16 - 14	03073LH▲	0.438	11.1	1.5D	2.193	1.567	1.253	0.938	
1/2 - 13	03083LH	0.5	12.7	1.5D	2.483	1.773	1.419	1.063	

BICYCLE THREADS		INSTALLED LENGTH				PRICE EACH PER INSERT (50/BAG)		
Thread Size	Part No.	inches	mm	D's	50+	100+	500+	
9/16 - 20	04090-20-0.5	0.5	12.7		2.414	1.690	1.207	
9/16 - 20	04090LH-20-0.5	0.5	12.7		3.210	2.248	1.605	

▲ Denotes non-popular parts - Price On Application. Minimum quantities and order values may apply.
 Only supplied in full bag quantities.
 Dry film lubing and plating available.

Bulk Inserts Screw Locking - Metric

Only Supplied in Full Bag Quantities



METRIC COURSE		INSTALLED LENGTH			METRIC FINE		PRICE EACH PER INSERT (100/BAG)			
Thread Size	Part No.	inches	mm	D's	Thread Size	Part No.	100+	500+	1000+	5000+
M2.2 - 0.45	15012 ▲	0.087	2.2	1D			0.665	0.476	0.379	0.281
	15013 ▲	0.130	3.3	1.5D			0.714	0.510	0.408	0.302
	15014 ▲	0.173	4.4	2D			0.738	0.528	0.421	0.313
	15015 ▲	0.217	5.5	2.5D			0.813	0.581	0.465	0.344
	15016 ▲	0.260	6.6	3D			0.885	0.632	0.506	0.375
M2.5 - 0.45	15252	0.098	2.5	1D			0.604	0.432	0.344	0.261
	15253	0.150	3.8	1.5D			0.642	0.459	0.367	0.271
	15254	0.197	5	2D			0.676	0.484	0.386	0.292
	15255 ▲	0.248	6.3	2.5D			0.725	0.518	0.415	0.313
	15256 ▲	0.295	7.5	3D			0.813	0.581	0.465	0.344
M3 - 0.5	15032	0.118	3	1D			0.604	0.432	0.344	0.261
	15033	0.177	4.5	1.5D			0.642	0.459	0.367	0.271
	15034	0.236	6	2D			0.676	0.484	0.386	0.292
	15035 ▲	0.296	7.5	2.5D			0.725	0.518	0.415	0.313
	15036 ▲	0.354	9	3D			0.813	0.581	0.465	0.344
M3.5 - 0.6	15352 ▲	0.138	3.5	1D			0.640	0.457	0.366	0.271
	15353	0.209	5.3	1.5D			0.689	0.492	0.393	0.292
	15354 ▲	0.276	7	2D			0.738	0.528	0.421	0.313
	15355 ▲	0.346	8.8	2.5D			0.813	0.581	0.465	0.344
	15356 ▲	0.413	10.5	3D			0.885	0.632	0.506	0.375
M4 - 0.7	15042	0.157	4	1D			0.604	0.432	0.344	0.261
	15043	0.236	6	1.5D			0.642	0.459	0.367	0.271
	15044	0.315	8	2D			0.676	0.484	0.386	0.292
	15045 ▲	0.394	10	2.5D			0.725	0.518	0.415	0.313
	15046 ▲	0.472	12	3D			0.813	0.581	0.465	0.344
M5 - 0.8	15052	0.197	5	1D			0.604	0.432	0.344	0.261
	15053	0.295	7.5	1.5D			0.642	0.459	0.367	0.271
	15054	0.394	10	2D			0.676	0.484	0.386	0.292
	15055 ▲	0.492	12.5	2.5D			0.763	0.545	0.437	0.323
	15056 ▲	0.591	15	3D			0.862	0.615	0.492	0.375
M6 - 1	15062	0.236	6	1D			0.661	0.472	0.376	0.281
	15063	0.354	9	1.5D			0.725	0.518	0.415	0.313
	15064	0.472	12	2D			0.763	0.545	0.437	0.323
	15065 ▲	0.591	15	2.5D			0.828	0.591	0.473	0.354
	15066 ▲	0.709	18	3D			0.906	0.647	0.518	0.386
M7 - 1	15072 ▲	0.276	7	1D			0.676	0.484	0.386	0.292
	15073 ▲	0.413	10.5	1.5D			0.792	0.567	0.453	0.344
	15074 ▲	0.551	14	2D			0.873	0.624	0.497	0.375
	15075 ▲	0.689	17.5	2.5D			1.085	0.775	0.620	0.469
	15076 ▲	0.827	21	3D			1.294	0.924	0.739	0.553
M8 - 1.25	15082	0.315	8	1D	M8 - 1	17082	0.698	0.500	0.400	0.302
	15083	0.472	12	1.5D		17083 ▲	0.792	0.567	0.453	0.344
	15084	0.630	16	2D		17084 ▲	0.873	0.624	0.497	0.375
	15085 ▲	0.787	20	2.5D		17085 ▲	1.085	0.775	0.620	0.469
	15086 ▲	0.945	24	3D		17086 ▲	1.294	0.924	0.739	0.553
		0.315	8	1D	M8 - 0.75	18082 ▲	0.982	0.703	0.561	0.417
		0.472	12	1.5D		18083 ▲	1.112	0.795	0.637	0.480
		0.630	16	2D		18084 ▲	1.269	0.906	0.725	0.542
		0.787	20	2.5D		18085 ▲	1.526	1.091	0.873	0.657
		0.945	24	3D		18086 ▲	1.810	1.294	1.034	0.771
M10 - 1.5	15102	0.394	10	1D	M10 - 1.25	17102 ▲	0.982	0.702	0.561	0.417
	15103	0.591	15	1.5D		17103	1.112	0.795	0.637	0.480
	15104	0.787	20	2D		17104 ▲	1.269	0.906	0.725	0.542
	15105	0.984	25	2.5D		17105 ▲	1.526	1.091	0.873	0.657
	15106	1.181	30	3D		17106 ▲	1.810	1.294	1.034	0.771

Bulk Inserts Screw Locking - Metric

Only Supplied in Full Bag Quantities



METRIC COURSE		INSTALLED LENGTH			METRIC FINE		PRICE EACH PER INSERT (100/BAG)			
Thread Size	Part No.	inches	mm	D's	Thread Size	Part No.	100+	500+	1000+	5000+
		0.394	10	1D	M10 - 1	18102 ▲	0.982	0.703	0.561	0.417
		0.591	15	1.5D		18103 ▲	1.112	0.795	0.637	0.480
		0.787	20	2D		18104 ▲	1.269	0.906	0.725	0.542
		0.984	25	2.5D		18105 ▲	1.526	1.091	0.873	0.657
		1.181	30	3D		18106 ▲	1.810	1.294	1.034	0.771
M12 - 1.75	15122	0.472	12	1D	M12 - 1.5	17122 ▲	1.437	1.027	0.821	0.615
	15123	0.709	18	1.5D		17123 ▲	1.552	1.109	0.887	0.667
	15124	0.945	24	2D		17124 ▲	1.810	1.294	1.034	0.771
	15125	1.181	30	2.5D		17125 ▲	2.328	1.662	1.330	1.001
	15126 ▲	1.417	36	3D		17126 ▲	2.586	1.847	1.478	1.105
		0.472	12	1D	M12 - 1.25	18122 ▲	1.437	1.027	0.821	0.615
		0.709	18	1.5D		18123	1.552	1.109	0.887	0.667
		0.945	24	2D		18124 ▲	1.810	1.294	1.034	0.771
		1.181	30	2.5D		18125 ▲	2.328	1.662	1.330	1.001
		1.417	36	3D		18126 ▲	2.586	1.847	1.478	1.105

METRIC COURSE		INSTALLED LENGTH			METRIC FINE		PRICE EACH PER INSERT (50/BAG)			
Thread Size	Part No.	inches	mm	D's	Thread Size	Part No.	50+	100+	500+	1000+
M14 - 2	15142	0.551	14	1D	M14 - 1.5	17142 ▲	1.916	1.370	1.095	0.824
	15143	0.827	21	1.5D		17143	2.459	1.756	1.404	1.053
	15144 ▲	1.102	28	2D		17144 ▲	3.073	2.194	1.756	1.314
	15145 ▲	1.378	35	2.5D		17145 ▲	3.811	2.723	2.177	1.637
	15146 ▲	1.654	42	3D		17146 ▲	4.423	3.161	2.528	1.897
M16 - 2	15162	0.630	16	1D	M16 - 1.5	17162	2.459	1.756	1.404	1.053
	15163	0.945	24	1.5D		17163 ▲	3.026	2.162	1.730	1.303
	15164	1.260	32	2D		17164 ▲	3.880	2.771	2.216	1.658
	15165 ▲	1.575	40	2.5D		17165 ▲	4.657	3.327	2.660	1.991
	15166 ▲	1.890	48	3D		17166 ▲	5.432	3.880	3.105	2.325
M18 - 2.5	15182 ▲	0.709	18	1D	M18 - 2	17182 ▲	3.516	2.511	2.009	1.512
	15183	1.063	27	1.5D		17183 ▲	4.139	2.957	2.364	1.772
	15184 ▲	1.417	36	2D		17184 ▲	5.432	3.880	3.105	2.325
	15185 ▲	1.772	45	2.5D		17185 ▲	6.725	4.804	3.844	2.888
	15186 ▲	2.126	54	3D		17186 ▲	8.018	5.727	4.582	3.440

METRIC COURSE		INSTALLED LENGTH			METRIC FINE		PRICE EACH PER INSERT (25/BAG)			
Thread Size	Part No.	inches	mm	D's	Thread Size	Part No.	25+	125+	250+	500+
M20 - 2.5	15202	0.787	20	1D	M20 - 2	17202 ▲	4.914	3.511	2.807	2.106
	15203	1.181	30	1.5D		17203 ▲	5.691	4.066	3.253	2.439
	15204 ▲	1.575	40	2D		17204	6.467	4.618	3.696	2.773
	15205 ▲	1.969	50	2.5D		17205 ▲	7.128	5.089	4.072	3.055
	15206 ▲	2.362	60	3D		17206 ▲	8.356	5.968	4.775	3.586
M22 - 2.5	15222 ▲	0.866	22	1D	M22 - 2	17222 ▲	6.208	4.435	3.548	2.658
	15223	1.299	33	1.5D		17223 ▲	7.113	5.082	4.066	3.055
	15224 ▲	1.732	44	2D		17224 ▲	8.276	5.912	4.730	3.545
	15225 ▲	2.165	55	2.5D		17225 ▲	9.708	6.936	5.546	4.160
	15226 ▲	2.598	66	3D		17226 ▲	11.304	8.074	6.459	4.848
M24 - 3	15242	0.945	24	1D	M24 - 2	17242 ▲	7.759	5.543	4.435	3.326
	15243	1.417	36	1.5D		17243 ▲	8.796	6.282	5.026	3.774
	15244 ▲	1.890	48	2D		17244 ▲	10.087	7.206	5.764	4.326
	15245 ▲	2.362	60	2.5D		17245 ▲	12.157	8.683	6.946	5.213
	15246 ▲	2.835	72	3D		17246 ▲	13.709	9.792	7.833	5.880

▲ Denotes non-popular parts - Price On Application. Minimum quantities and order values may apply.

Only supplied in full bag quantities.

Dry film lubing and plating available.

Bulk Inserts Screw Locking - Metric

Only Supplied in Full Bag Quantities



METRIC COURSE		INSTALLED LENGTH			METRIC FINE		PRICE EACH PER INSERT (10/BAG)			
Thread Size	Part No.	inches	mm	D's	Thread Size	Part No.	+10	50+	100+	500+
M27 - 3	15272	1.063	27	1D	M27 - 2	17272 ▲	11.304	8.074	6.459	4.848
	15273	1.594	40.5	1.5D		17273 ▲	13.271	9.478	7.583	5.692
	15274	2.126	54	2D		17274 ▲	15.482	11.059	8.846	6.630
	15275	2.657	67.5	2.5D		17275 ▲	18.106	12.933	10.347	7.756
	15276	3.189	81	3D		17276 ▲	20.693	14.781	11.824	8.872
M30 - 3.5	15302 ▲	1.181	30	1D	M30 - 2	17302 ▲	14.744	10.530	8.424	6.318
	15303 ▲	1.772	45	1.5D		17303 ▲	14.744	10.530	8.424	6.318
	15304 ▲	2.362	60	2D		17304 ▲	17.446	12.463	9.968	7.475
	15305 ▲	2.953	75	2.5D		17305 ▲	20.693	14.781	11.824	8.872
	15306 ▲	3.543	90	3D		17306 ▲	23.279	16.628	13.302	9.977
M30 - 3	15302-3 ▲	1.181	30	1D			12.286	8.778	7.021	5.265
	15303-3 ▲	1.772	45	1.5D			14.744	10.530	8.424	6.318
	15304-3 ▲	2.362	60	2D			17.446	12.463	9.968	7.475
	15305-3 ▲	2.953	75	2.5D			20.693	14.781	11.824	8.872
	15306-3 ▲	3.543	90	3D			23.279	16.628	13.302	9.977
M36 - 4	15362 ▲	1.417	36	1D	M36 - 3	17362 ▲	15.520	11.085	8.869	6.651
	15363 ▲	2.126	54	1.5D		17363 ▲	18.106	12.933	10.347	7.756
	15364 ▲	2.835	72	2D		17364 ▲	23.279	16.628	13.302	9.977
	15365 ▲	3.543	90	2.5D		17365 ▲	28.452	20.322	16.259	12.197
	15366 ▲	4.252	108	3D		17366 ▲	33.626	24.018	19.214	14.407
M39 - 4	15392 ▲	1.535	39	1D	M39 - 3	17392 ▲	16.812	12.009	9.608	7.204
	15393 ▲	2.303	58.5	1.5D		17393 ▲	20.693	14.781	11.824	8.872
	15394 ▲	3.071	78	2D		17394 ▲	25.864	18.475	14.781	11.082

▲ Denotes non-popular parts - Price On Application. Minimum quantities and order values may apply.
 Only supplied in full bag quantities.
 Dry film lubing and plating available.

Bulk Inserts Screw Locking - UNC/UNF

Only Supplied in Full Bag Quantities



UNC Thread Size	INSTALLED LENGTH				UNF Thread Size	PRICE EACH PER INSERT (100/BAG)				
	Part No.	inches	mm	D's		Part No.	100+	500+	1000+	5000+
#2 - 56	13522	0.086	2.2	1D			0.776	0.555	0.443	0.334
	13523	0.129	3.3	1.5D			0.841	0.603	0.480	0.365
	13524	0.172	4.4	2D			0.880	0.628	0.502	0.375
	13525	0.215	5.5	2.5D			0.932	0.665	0.533	0.396
	13526 ▲	0.258	6.6	3D			1.024	0.731	0.585	0.438
#3 - 48	13532 ▲	0.099	2.5	1D	#3 - 56	14532 ▲	1.294	0.924	0.739	0.553
	13533	0.149	3.8	1.5D		14533 ▲	1.397	0.998	0.798	0.594
	13534	0.198	5	2D		14534 ▲	1.475	1.053	0.843	0.636
	13535 ▲	0.248	6.3	2.5D			1.552	1.109	0.887	0.667
	13536 ▲	0.297	7.5	3D			1.708	1.219	0.976	0.730
#4 - 40	13542	0.112	2.8	1D	#4 - 48	14542 ▲	0.595	0.425	0.340	0.250
	13543	0.168	4.3	1.5D		14543 ▲	0.634	0.455	0.362	0.271
	13544	0.224	5.7	2D		14544	0.673	0.480	0.385	0.292
	13545	0.280	7.1	2.5D			0.725	0.518	0.415	0.313
	13546	0.336	8.5	3D			0.776	0.555	0.443	0.334
#5 - 40	13552	0.125	3.2	1D			0.595	0.425	0.340	0.250
	13553	0.188	4.8	1.5D			0.634	0.455	0.362	0.271
	13554 ▲	0.250	6.4	2D			0.673	0.480	0.385	0.292
	13555 ▲	0.313	7.9	2.5D			0.725	0.518	0.415	0.313
	13556	0.375	9.5	3D			0.776	0.555	0.443	0.334
#6 - 32	13562	0.138	3.5	1D	#6 - 40	14562 ▲	0.595	0.425	0.340	0.250
	13563	0.207	5.3	1.5D		14563	0.634	0.455	0.362	0.271
	13564	0.276	7	2D		14564	0.673	0.480	0.385	0.292
	13565	0.345	8.8	2.5D			0.725	0.518	0.415	0.313
	13566	0.414	10.5	3D			0.776	0.555	0.443	0.334
#8 - 32	13582	0.164	4.2	1D	#8 - 36	14582	0.595	0.425	0.340	0.250
	13583	0.246	6.2	1.5D		14583	0.634	0.455	0.362	0.271
	13584	0.328	8.3	2D		14584 ▲	0.673	0.480	0.385	0.292
	13585	0.410	10.4	2.5D			0.725	0.518	0.415	0.313
	13586	0.492	12.5	3D			0.776	0.555	0.443	0.334
#10 - 24	13602	0.190	4.8	1D	#10 - 32	14602	0.595	0.425	0.340	0.250
	13603	0.285	7.2	1.5D		14603	0.634	0.455	0.362	0.271
	13604	0.380	9.7	2D		14604	0.673	0.480	0.385	0.292
	13605 ▲	0.475	12.1	2.5D		14605	0.725	0.518	0.415	0.313
	13606	0.570	14.5	3D		14606	0.776	0.555	0.443	0.334
#12 - 24	13622	0.216	5.5	1D			0.686	0.491	0.391	0.292
	13623 ▲	0.324	8.2	1.5D			0.713	0.509	0.407	0.302
	13624 ▲	0.432	11	2D			0.804	0.573	0.459	0.344
	13625 ▲	0.540	13.7	2.5D			0.855	0.610	0.489	0.365
	13626 ▲	0.648	16.5	3D			0.932	0.665	0.533	0.396
1/4 - 20	13042	0.250	6.4	1D	1/4 - 28	14042	0.686	0.491	0.391	0.292
	13043	0.375	9.5	1.5D		14043	0.713	0.509	0.407	0.302
	13044	0.500	12.7	2D		14044	0.804	0.573	0.459	0.344
	13045	0.625	15.9	2.5D		14045 ▲	0.855	0.610	0.489	0.365
	13046	0.750	19.1	3D		14046 ▲	0.932	0.665	0.533	0.396
5/16 - 18	13052	0.313	8	1D	5/16 - 24	14052	0.751	0.537	0.428	0.323
	13053	0.470	11.9	1.5D		14053	0.790	0.565	0.450	0.334
	13054	0.626	15.9	2D		14054	0.867	0.620	0.495	0.375
	13055 ▲	0.783	19.9	2.5D		14055	0.982	0.703	0.561	0.417
	13056 ▲	0.939	23.9	3D		14056 ▲	1.112	0.795	0.637	0.480
3/8 - 16	13062	0.375	9.5	1D	3/8 - 24	14062	1.010	0.721	0.577	0.438
	13063	0.563	14.3	1.5D		14063	1.112	0.795	0.637	0.480
	13064	0.750	19.1	2D		14064	1.294	0.924	0.739	0.553
	13065 ▲	0.938	23.8	2.5D		14065 ▲	1.475	1.053	0.843	0.636
	13066	1.125	28.6	3D		14066 ▲	1.683	1.201	0.961	0.719

Bulk Inserts Screw Locking - UNC/UNF

Only Supplied in Full Bag Quantities



UNC Thread Size	Part No.	INSTALLED LENGTH			UNF Thread Size	Part No.	PRICE EACH PER INSERT (100/BAG)			
		inches	mm	D's			100+	500+	1000+	5000+
7/16 - 14	13072	0.438	11.1	1D	7/16 - 20	14072	1.242	0.887	0.710	0.532
	13073	0.657	16.7	1.5D		14073	1.320	0.943	0.755	0.563
	13074	0.876	22.3	2D		14074	1.475	1.053	0.843	0.636
	13075	1.095	27.8	2.5D		14075	1.810	1.294	1.034	0.771
	13076	1.314	33.4	3D		14076	2.069	1.478	1.182	0.886
1/2 - 13	13082	0.500	12.7	1D	1/2 - 20	14082	1.423	1.016	0.813	0.615
	13083	0.750	19.1	1.5D		14083	1.514	1.082	0.864	0.646
	13084	1.000	25.4	2D		14084	1.708	1.219	0.976	0.730
	13085	1.250	31.8	2.5D		14085	2.069	1.478	1.182	0.886
	13086	1.500	38.1	3D		14086	2.459	1.756	1.404	1.053

UNC Thread Size	Part No.	INSTALLED LENGTH			UNF Thread Size	Part No.	PRICE EACH PER INSERT (50/BAG)			
		inches	mm	D's			50+	100+	500+	1000+
9/16 - 12	13092	0.56	14.3	1D	9/16 - 18	14092	1.810	1.294	1.034	0.771
	13093	0.85	21.5	1.5D		14093 ▲	2.069	1.478	1.182	0.886
	13094 ▲	1.13	28.6	2D		14094 ▲	2.975	2.126	1.700	1.272
	13095 ▲	1.41	35.8	2.5D		14095 ▲	3.752	2.680	2.143	1.605
	13096 ▲	1.69	42.9	3D		14096 ▲	4.528	3.234	2.586	1.939
5/8 - 11	13102	0.63	15.9	1D	5/8 - 18	14102	2.431	1.737	1.389	1.043
	13103	0.94	23.8	1.5D		14103	2.975	2.126	1.700	1.272
	13104	1.25	31.8	2D		14104 ▲	3.777	2.697	2.158	1.616
	13105 ▲	1.56	39.7	2.5D		14105 ▲	4.553	3.253	2.601	1.949
	13106 ▲	1.88	47.6	3D		14106 ▲	5.432	3.880	3.105	2.325
3/4 - 10	13122	0.69	17.5	1D	3/4 - 16	14122	3.493	2.495	1.995	1.501
	13123	1.03	26.2	1.5D		14123	4.126	2.948	2.358	1.772
	13124 ▲	1.38	35	2D		14124	5.432	3.880	3.105	2.325
	13125 ▲	1.72	43.7	2.5D		14125	6.622	4.730	3.783	2.836
	13126 ▲	2.06	52.4	3D		14126 ▲	7.759	5.543	4.435	3.326

UNC Thread Size	Part No.	INSTALLED LENGTH			UNF Thread Size	Part No.	PRICE EACH PER INSERT (25/BAG)			
		inches	mm	D's			25+	125+	250+	500+
7/8 - 9	13142	0.75	19.1	1D	7/8 - 14	14142 ▲	5.949	4.250	3.400	2.554
	13143	1.13	28.6	1.5D		14143 ▲	6.983	4.988	3.991	2.992
	13144	1.50	38.1	2D		14144 ▲	8.018	5.727	4.582	3.440
	13145 ▲	1.88	47.6	2.5D		14145 ▲	9.053	6.467	5.173	3.878
1" - 8	13162	0.88	22.2	1D	1" - 12	14162 ▲	7.631	5.451	4.361	3.273
	13163	1.31	33.3	1.5D		14163 ▲	8.796	6.282	5.026	3.774
	13164	1.75	44.5	2D		14164 ▲	10.087	7.206	5.764	4.326
	13165 ▲	2.19	55.6	2.5D		14165 ▲	11.898	8.498	6.799	5.098
	13166 ▲	2.63	66.7	3D		14166 ▲	13.449	9.608	7.685	5.765
		1.00	25.4	1D	1" - 14	14162-14 ▲	7.631	5.451	4.361	3.273
		1.50	38.1	1.5D		14163-14 ▲	8.796	6.282	5.026	3.774
		2.00	50.8	2D		14164-14 ▲	10.087	7.206	5.764	4.326
		2.50	63.5	2.5D		14165-14 ▲	11.898	8.498	6.799	5.098
		3.00	76.2	3D		14166-14 ▲	13.449	9.608	7.685	5.765

▲ Denotes non-popular parts - Price On Application. Minimum quantities and order values may apply.
 Only supplied in full bag quantities.
 Dry film lubing and plating available.

Bulk Inserts Screw Locking - UNC/UNF

Only Supplied in Full Bag Quantities



UNC Thread Size	Part No.	INSTALLED LENGTH			UNF Thread Size	Part No.	PRICE EACH PER INSERT (10/BAG)			
		inches	mm	D's			10+	50+	100+	500+
1 1/8 - 7	13182	1.13	28.6	1D	1 1/8 - 12	14182 ▲	12.286	8.778	7.021	5.265
	13183	1.69	42.9	1.5D		14183 ▲	12.933	9.239	7.390	5.546
	13184	2.25	57.2	2D		14184 ▲	17.201	12.286	9.830	7.370
		2.81	71.4	2.5D		14185 ▲	19.657	14.040	11.233	8.423
		3.38	85.7	3D		14186 ▲	22.116	15.797	12.637	9.476
1 1/4 - 7	13202	1.25	31.8	1D	1 1/4 - 12	14202 ▲	13.515	9.655	7.722	5.796
	13203	1.88	47.6	1.5D		14203 ▲	14.744	10.530	8.424	6.318
	13204	2.50	63.5	2D		14204 ▲	18.429	13.165	10.530	7.902
	13205	3.13	79.4	2.5D		14205 ▲	22.116	15.797	12.637	9.476
	13206	3.75	95.3	3D		14206 ▲	24.572	17.552	14.040	10.529
1 3/8 - 6	13222	1.38	34.9	1D	1 3/8 - 12	14222 ▲	14.744	10.530	8.424	6.318
	13223	2.06	52.4	1.5D		14223 ▲	15.520	11.085	8.869	6.651
	13224	2.75	69.9	2D		14224 ▲	22.116	15.797	12.637	9.476
	13225	3.44	87.3	2.5D		14225 ▲	27.030	19.307	15.446	11.582
	13226	4.13	104.8	3D		14226 ▲	29.487	21.063	16.850	12.635
1 1/2 - 6	13242	1.50	38.1	1D	1 1/2 - 12	14242 ▲	17.201	12.286	9.830	7.370
	13243	2.25	57.2	1.5D		14243 ▲	20.693	14.781	11.824	8.872
	13244	3.00	76.2	2D		14244 ▲	27.030	19.307	15.446	11.582
	13245	3.75	95.3	2.5D		14245 ▲	34.401	24.572	19.657	14.741
	13246	4.50	114.3	3D		14246 ▲	39.316	28.083	22.466	16.847

8 TPI UNC Thread Size	Part No.	INSTALLED LENGTH					PRICE EACH PER INSERT (10/BAG)			
		inches	mm	D's			10+	50+	100+	500+
1 1/8 - 8	16182 ▲	1.13	28.6	1D			10.966	7.833	6.266	4.702
	16183 ▲	1.69	42.9	1.5D			12.830	9.165	7.331	5.494
	16184 ▲	2.25	57.2	2D			14.692	10.494	8.395	6.297
1 1/4 - 8	16202 ▲	1.25	31.8	1D			12.415	8.869	7.094	5.317
	16203 ▲	1.88	47.6	1.5D			14.484	10.347	8.276	6.213
	16204 ▲	2.50	63.5	2D			18.623	13.302	10.642	7.986
1 3/8 - 8	16222 ▲	1.38	34.9	1D			14.484	10.347	8.276	6.213
	16223 ▲	2.06	52.4	1.5D			16.140	11.529	9.223	6.922
	16224 ▲	2.75	69.9	2D			20.693	14.781	11.824	8.872
1 1/2 - 8	16242 ▲	1.50	38.1	1D			16.554	11.824	9.460	7.099
	16243 ▲	2.25	57.2	1.5D			19.244	13.745	10.996	8.246
	16244 ▲	3.00	76.2	2D			24.830	17.736	14.188	10.644
1 5/8 - 8	16262 ▲	1.63	41.3	1D			28.969	20.693	16.554	12.416
	16263 ▲	2.44	61.9	1.5D			32.073	22.909	18.327	13.751
	16264 ▲	3.25	82.6	2D			41.384	29.560	23.648	17.733
1 3/4 - 8	16282 ▲	1.75	44.5	1D			28.969	20.693	16.554	12.416
	16283 ▲	2.63	66.7	1.5D			36.211	25.864	20.693	15.523
	16284 ▲	3.50	88.9	2D			45.523	32.517	26.012	19.505
1 7/8 - 8	16302 ▲	1.88	47.6	1D			33.108	23.648	18.918	14.188
	16303 ▲	2.81	71.4	1.5D			41.384	29.560	23.648	17.733
	16304 ▲	3.75	95.3	2D			51.731	36.950	29.560	22.174
2" - 8	16322 ▲	2.00	50.8	1D			35.177	25.126	20.100	15.075
	16323 ▲	3.00	76.2	1.5D			45.523	32.517	26.012	19.505
	16324 ▲	4.00	101.6	2D			57.938	41.384	33.108	24.832

▲ Denotes non-popular parts - Price On Application. Minimum quantities and order values may apply.
 Only supplied in full bag quantities.
 Dry film lubing and plating available.

Inserts - Stripfeed - Metric



METRIC						
FREE RUNNING	INSERT LENGTH					PRICE EACH PER INSERT
Thread Size	Part No.	inches	mm	D's	Qty/Reel	(PACKED ON REELS)
M2.2 - 0.45	05012SF	0.087	2.2	1D	1,000	0.365
	05013SF	0.130	3.3	1.5D	1,000	0.392
	05014SF	0.173	4.4	2D	1,000	0.404
M2.5 - 0.45	05252SF	0.098	2.5	1D	1,000	0.330
	05253SF	0.150	3.8	1.5D	1,000	0.351
	05254SF	0.197	5	2D	1,000	0.370
M3 - 0.5	05032SF	0.118	3	1D	1,000	0.330
	05033SF	0.177	4.5	1.5D	1,000	0.351
	05034SF	0.236	6	2D	1,000	0.370
M4 - 0.7	05042SF	0.157	4	1D	1,000	0.330
	05043SF	0.236	6	1.5D	1,000	0.351
	05044SF	0.315	8	2D	1,000	0.370
M5 - 0.8	05052SF	0.197	5	1D	1,000	0.330
	05053SF	0.295	7.5	1.5D	500	0.440
	05054SF	0.394	10	2D	500	0.464
M6 - 1	05062SF	0.236	6	1D	500	0.451
	05063SF	0.354	9	1.5D	500	0.498
	05064SF	0.472	12	2D	500	0.524
M8 - 1.25	05082SF	0.315	8	1D	500	0.670
	05083SF	0.472	12	1.5D	500	0.760
	05084SF	0.630	16	2D	500	0.836
M8 - 1	07082SF ▲	0.315	8	1D	500	0.760
	07083SF ▲	0.472	12	1.5D	500	0.670
	07084SF ▲	0.630	16	2D	500	0.836
M10 - 1.5	05102SF	0.394	10	1D	250	0.945
	05103SF	0.591	15	1.5D	250	1.068
	05104SF ▲	0.787	20	2D	250	1.217
M12 - 1.75	05122SF ▲	0.472	12	1D	125	1.378
	05123SF ▲	0.709	18	1.5D	125	1.490
	05124SF ▲	0.945	24	2D	125	1.739

SCREW LOCKING						
INSERT LENGTH	PRICE EACH PER INSERT					
Thread Size	Part No.	inches	mm	D's	Qty/Reel	(PACKED ON REELS)
M2.2 - 0.45	15012SF ▲	0.087	2.2	1D	1,000	0.455
	15013SF ▲	0.130	3.3	1.5D	1,000	0.489
	15014SF ▲	0.173	4.4	2D	1,000	0.505
M2.5 - 0.45	15252SF ▲	0.098	2.5	1D	1,000	0.413
	15253SF ▲	0.150	3.8	1.5D	1,000	0.440
	15254SF ▲	0.197	5	2D	1,000	0.463
M3.5 - 0.6	15352SF ▲	0.138	3.5	1D	1,000	0.439
	15353SF ▲	0.209	5.3	1.5D	1,000	0.471
	15354SF ▲	0.276	7	2D	1,000	0.505
M4 - 0.7	15042SF	0.157	4	1D	1,000	0.413
	15043SF	0.236	6	1.5D	1,000	0.440
	15044SF	0.315	8	2D	1,000	0.463
M5 - 0.8	15052SF	0.197	5	1D	1,000	0.413
	15053SF	0.295	7.5	1.5D	500	0.440
	15054SF	0.394	10	2D	500	0.463
M6 - 1	15062SF	0.236	6	1D	500	0.451
	15063SF	0.354	9	1.5D	500	0.497
	15064SF	0.472	12	2D	500	0.523
M8 - 1.25	15082SF	0.315	8	1D	500	0.838
	15083SF	0.472	12	1.5D	500	0.951
	15084SF	0.630	16	2D	500	1.047
M10 - 1.5	15102SF ▲	0.472	10	1D	125	1.178
	15103SF ▲	0.709	15	1.5D	125	1.334
	15104SF ▲	0.945	20	2D	125	1.522
M12 - 1.75	15122SF ▲	0.472	12	1D	125	1.723
	15123SF ▲	0.709	18	1.5D	125	1.862
	15124SF ▲	0.945	24	2D	125	2.172

Australian Price List Effective July 2013
All prices are exclusive of GST

▲ Denotes non-popular parts - Price On Application. Minimum quantities and order values may apply.
Dry film lubing and plating available.

Inserts - Stripfeed - Inch



UNC FREE RUNNING					UNF FREE RUNNING			PRICE EACH PER INSERT
Thread Size	Part No.	INSERT LENGTH		D's	Thread Size	Part No.	Qty/Reel	(PACKED ON REELS)
#2 - 56	03522SF	0.086	2.2	1D			1,000	0.425
	03523SF	0.129	3.3	1.5D			1,000	0.461
	03524SF ▲	0.172	4.4	2D			1,000	0.483
#3 - 48	03532SF ▲	0.099	2.5	1D	#3 - 56	04532SF ▲	1,000	0.709
	03533SF ▲	0.149	3.8	1.5D		04533SF ▲	1,000	0.766
	03534SF ▲	0.198	5	2D		04534SF ▲	1,000	0.809
#4 - 40	03542SF	0.112	2.8	1D	#4 - 48	04542SF ▲	1,000	0.326
	03543SF	0.168	4.3	1.5D		04543SF ▲	1,000	0.347
	03544SF	0.224	5.7	2D		04544SF ▲	1,000	0.369
#5 - 40	03552SF	0.125	3.2	1D			1,000	0.326
	03553SF	0.188	4.8	1.5D			1,000	0.347
	03554SF	0.250	6.4	2D			1,000	0.369
#6 - 32	03562SF	0.138	3.5	1D	#6 - 40	04562SF ▲	1,000	0.326
	03563SF	0.207	5.3	1.5D		04563SF ▲	1,000	0.347
	03564SF	0.276	7	2D		04564SF ▲	1,000	0.369
#8 - 32	03582SF	0.164	4.2	1D	#8 - 36	04582SF ▲	1,000	0.326
	03583SF	0.246	6.2	1.5D		04583SF ▲	1,000	0.347
	03584SF	0.328	8.3	2D		04584SF ▲	1,000	0.369
#10 - 24	03602SF	0.190	4.8	1D	#10 - 32	04602SF	1,000	0.326
	03603SF	0.285	7.2	1.5D		04603SF	500	0.435
	03604SF	0.380	9.7	2D		04604SF	500	0.461
1/4 - 20	03042SF	0.250	6.4	1D	1/4 - 28	04042SF	500	0.470
	03043SF	0.375	9.5	1.5D		04043SF	500	0.488
	03044SF	0.500	12.7	2D		04044SF ▲	500	0.550
5/16 - 18	03052SF	0.312	7.9	1D	5/16 - 24	04052SF ▲	250	0.721
	03053SF	0.468	11.9	1.5D		04053SF	250	0.757
	03054SF ▲	0.624	15.8	2D		04054SF ▲	250	0.833
3/8 - 16	03062SF ▲	0.375	9.5	1D			250	0.970
	03063SF ▲	0.563	14.3	1.5D			250	1.068
	03064SF ▲	0.750	19.1	2D			250	1.241

UNC SCREW LOCKING					UNF SCREW LOCKING			PRICE EACH PER INSERT
Thread Size	Part No.	INSERT LENGTH		D's	Thread Size	Part No.	Qty/Reel	(PACKED ON REELS)
#2 - 56	13522SF	0.086	2.2	1D			1,000	0.532
	13523SF	0.129	3.3	1.5D			1,000	0.575
	13524SF	0.172	4.4	2D			1,000	0.603
#3 - 48	13532SF	0.099	2.5	1D	#3 - 56	14532SF ▲	1,000	0.886
	13533SF	0.149	3.8	1.5D		14533SF ▲	1,000	0.957
	13534SF	0.198	5	2D		14534SF ▲	1,000	1.011
#4 - 40	13542SF	0.112	2.8	1D	#4 - 48	14542SF ▲	1,000	0.408
	13543SF	0.168	4.3	1.5D		14543SF ▲	1,000	0.434
	13544SF	0.224	5.7	2D		14544SF ▲	1,000	0.462
#5 - 40	13552SF	0.125	3.2	1D			1,000	0.408
	13553SF	0.188	4.8	1.5D			1,000	0.434
	13554SF	0.250	6.4	2D			1,000	0.462
#6 - 32	13562SF	0.138	3.5	1D	#6 - 40	14562SF ▲	1,000	0.408
	13563SF	0.207	5.3	1.5D		14563SF ▲	1,000	0.434
	13564SF	0.276	7	2D		14564SF ▲	1,000	0.462
#8 - 32	13582SF	0.164	4.2	1D	#8 - 36	14582SF ▲	1,000	0.408
	13583SF	0.246	6.2	1.5D		14583SF ▲	1,000	0.434
	13584SF	0.328	8.3	2D		14584SF ▲	1,000	0.462

Australian Price List Effective July 2013
All prices are exclusive of GST

▲ Denotes non-popular parts - Price On Application. Minimum quantities and order values may apply.
Dry film lubing and plating available.

Inserts - Stripfeed - Inch



UNC SCREW LOCKING		INSERT LENGTH			UNF SCREW LOCKING		PRICE EACH PER INSERT (PACKED ON REELS)	
Thread Size	Part No.	inches	mm	D's	Thread Size	Part No.	Qty/Reel	
#10 - 24	13602SF ▲	0.190	4.8	1D	#10 - 32	14602SF	1,000	0.408
	13603SF ▲	0.285	7.2	1.5D		14603SF	500	0.545
	13604SF ▲	0.380	9.7	2D		14604SF	500	0.575
1/4-20	13042SF	0.250	6.4	1D	1/4 - 28	14042SF	500	0.589
	13043SF	0.375	9.5	1.5D		14043SF	500	0.610
	13044SF	0.500	12.7	2D		14044SF ▲	500	0.688
5/16 - 18	13052SF ▲	0.375	9.5	1D	5/16 - 24	14052SF ▲	250	0.901
	13053SF ▲	0.563	14.3	1.5D		14053SF ▲	250	0.948
	13054SF ▲	0.750	19.1	2D		14054SF ▲	250	1.040
3/8 - 16	13062SF ▲	0.312	7.9	1D			250	1.211
	13063SF ▲	0.468	11.9	1.5D			250	1.334
	13064SF ▲	0.624	15.8	2D			250	1.552

▲ Denotes non-popular parts - Price On Application. Minimum quantities and order values may apply.
 Only supplied in full reel quantities.
 Dry film lubing and plating available.

Taps - Straight Flute Taps (Hand/Short Machine)

Metric - ISO Dimensions, HSS Material - 4H5H Tolerance



METRIC COARSE				METRIC MEDIUM				METRIC FINE			
Thread Size	Part No.	Type	Price	Thread Size	Part No.	Type	Price	Thread Size	Part No.	Type	Price
M2 - 0.4	45024	TAPER	58.90								
	45025	INTER	58.90								
	45026	BOTT	58.90								
M2.2 - 0.45	45014 ▲	TAPER	58.90								
	45015	INTER	58.90								
	45016	BOTT	58.90								
M2.5 - 0.45	45254	TAPER	42.95								
	45255	INTER	42.95								
	45256	BOTT	42.95								
M3 - 0.5	45034	TAPER	36.81								
	45035	INTER	36.81								
	45036	BOTT	36.81								
M3.5 - 0.6	45354	TAPER	42.95								
	45355	INTER	42.95								
	45356	BOTT	42.95								
M4 - 0.7	45044	TAPER	34.36								
	45045	INTER	34.36								
	45046	BOTT	34.36								
M5 - 0.8	45054	TAPER	34.36								
	45055	INTER	34.36								
	45056	BOTT	34.36								
M6 - 1	45064	TAPER	34.36								
	45065	INTER	34.36								
	45066	BOTT	34.36								
	45067	P/NOSE	49.08								
	45065LH	L/HAND	98.16								
M7 - 1	45074	TAPER	42.95								
	45075	INTER	42.95								
	45076	BOTT	42.95								
M8 - 1.25	45084	TAPER	40.49	M8 - 1	47084	TAPER	42.95	M8 - 0.75	48084 ▲	TAPER	51.53
	45085	INTER	40.49		47085	INTER	42.95		48085 ▲	INTER	51.53
	45086	BOTT	40.49		47086	BOTT	42.95		48086 ▲	BOTT	51.53
	45087	P/NOSE	61.35								
	45085LH	L/HAND	110.43								
M9 - 1.25	45094	TAPER	61.35	M9 - 1	47094 ▲	TAPER	61.35				
	45095	INTER	61.35		47095	INTER	61.35				
	45096 ▲	BOTT	61.35		47096	BOTT	61.35				
M10 - 1.5	45104	TAPER	49.08	M10 - 1.25	47104	TAPER	49.08	M10 - 1	48104	TAPER	55.22
	45105	INTER	49.08		47105	INTER	49.08		48105	INTER	55.22
	45106	BOTT	49.08		47106	BOTT	49.08		48106	BOTT	55.22
	45107	P/NOSE	67.49		47107	P/NOSE	67.49		48107	P/NOSE	79.76
	45105LH	L/HAND	172.01								
M11 - 1.5	45114	TAPER	67.49	M11 - 1.25	47114	TAPER	67.49	M11 - 1	48114	TAPER	85.89
	45115	INTER	67.49		47115	INTER	67.49		48115	INTER	85.89
	45116	BOTT	67.49		47116	BOTT	67.49		48116	BOTT	85.89

▲ Denotes non-popular parts - Price On Application. Minimum quantities and order values may apply.
 Only supplied in full reel quantities.
 Dry film lubing and plating available.

Taps - Straight Flute Taps (Hand/Short Machine)

Metric - ISO Dimensions, HSS Material - 4H5H Tolerance



METRIC COARSE				METRIC MEDIUM				METRIC FINE			
Thread Size	Part No.	Type	Price	Thread Size	Part No.	Type	Price	Thread Size	Part No.	Type	Price
M12 - 1.75	45124	TAPER	67.49	M12 - 1.5	47124	TAPER	67.49	M12 - 1.25	48124	TAPER	73.62
	45125	INTER	67.49		47125	INTER	67.49		48125	INTER	73.62
	45126	BOTT	67.49		47126	BOTT	67.49		48126	BOTT	73.62
	45127	P/NOSE	79.76						48127	P/NOSE	85.89
	45125LH	L/HAND	172.01								
								M12 - 1	48124-1 ▲	TAPER	116.57
									48125-1	INTER	116.57
									48126-1 ▲	BOTT	116.57
M13 - 1.75	45135	INTER	69.57	M13 - 1.5	47135	INTER	69.57	M13 - 1.25	48135	INTER	69.57
M14 - 2	45144	TAPER	79.76	M14 - 1.5	47144	TAPER	79.76	M14 - 1.25	48144	TAPER	83.44
	45145	INTER	79.76		47145	INTER	79.76		48145	INTER	83.44
	45146	BOTT	79.76		47146	BOTT	79.76		48146	BOTT	83.44
									48147	P/NOSE	95.71
M15 - 2	45154 ▲	TAPER	98.16	M15 - 1.5	47154 ▲	TAPER	98.16				
	45155	INTER	98.16		47155	INTER	98.16				
	45156	BOTT	98.16		47156	BOTT	98.16				
M16 - 2	45164	TAPER	92.03	M16 - 1.5	47164	TAPER	98.16				
	45165	INTER	92.03		47165	INTER	98.16				
	45166	BOTT	92.03		47166	BOTT	98.16				
M18 - 2.5	45184	TAPER	147.24	M18 - 2	47184	TAPER	159.51	M18 - 1.5	48184	TAPER	147.24
	45185	INTER	147.24		47185	INTER	159.51		48185	INTER	147.24
	45186	BOTT	147.24		47186	BOTT	159.51		48186	BOTT	147.24
									48187	P/NOSE	184.05
M20 - 2.5	45204	TAPER	159.51	M20 - 2	47204	TAPER	171.78	M20 - 1.5	48204	TAPER	165.65
	45205	INTER	159.51		47205	INTER	171.78		48205	INTER	165.65
	45206	BOTT	159.51		47206	BOTT	171.78		48206	BOTT	165.65
M22 - 2.5	45224	TAPER	184.05	M22 - 2	47224 ▲	TAPER	196.32	M22 - 1.5	48224	TAPER	184.05
	45225	INTER	184.05		47225	INTER	196.32		48225	INTER	184.05
	45226	BOTT	184.05		47226 ▲	BOTT	196.32		48226	BOTT	184.05
M24 - 3	45244	TAPER	220.86	M24 - 2	47244	TAPER	233.13	M24 - 1.5	48244	TAPER	220.86
	45245	INTER	220.86		47245	INTER	233.13		48245	INTER	220.86
	45246	BOTT	220.86		47246	BOTT	233.13		48246	BOTT	220.86
								M26 - 1.5	48264 ▲	TAPER	306.76
									48265	INTER	306.76
									48266	BOTT	306.76
M27 - 3	45274	TAPER	355.84	M27 - 2	47274	TAPER	380.38	M27 - 1.5	48274 ▲	TAPER	380.38
	45275	INTER	355.84		47275	INTER	380.38		48275	INTER	380.38
	45276	BOTT	355.84		47276 ▲	BOTT	380.38		48276 ▲	BOTT	380.38
M30 - 3.5	45304	TAPER	368.11	M30 - 2	47304	TAPER	392.65	M30 - 1.5	48304	TAPER	392.65
	45305	INTER	368.11		47305	INTER	392.65		48305	INTER	392.65
	45306	BOTT	368.11		47306	BOTT	392.65		48306	BOTT	392.65
M30 - 3	45305-3	INTER	368.11								
M33 - 3.5	45334	TAPER	429.46	M33 - 2	47334 ▲	TAPER	458.06				
	45335	INTER	429.46		47335	INTER	458.06				
	45336	BOTT	429.46		47336	BOTT	458.06				
M36 - 4	45364 ▲	TAPER	457.34	M36 - 3	47364 ▲	TAPER	613.51	M36 - 1.5	48364 ▲	TAPER	552.16
	45365	INTER	457.34		47365	INTER	613.51		48365	INTER	552.16
	45366	BOTT	457.34		47366	BOTT	613.51		48366 ▲	BOTT	552.16
M39 - 4	45394 ▲	TAPER	674.86	M39 - 3	47394 ▲	TAPER	736.21	M39 - 2	48394 ▲	TAPER	674.86
	45395	INTER	674.86		47395	INTER	736.21		48395	INTER	674.86
	45396 ▲	BOTT	674.86		47396 ▲	BOTT	736.21		48396 ▲	BOTT	674.86
M42 - 4.5	45424 ▲	TAPER	858.92	M42 - 3	47424 ▲	TAPER	920.27	M42 - 2	48424 ▲	TAPER	920.27
	45425 ▲	INTER	858.92		47425 ▲	INTER	920.27		48425 ▲	INTER	920.27
	45426 ▲	BOTT	858.92		47426	BOTT	920.27		48426	BOTT	920.27
M42 - 4	45425-4 ▲	INTER	858.92								

Taps - Straight Flute & Spiral Point Taps (Machine)

Metric - ISO Dimensions, HSS Material - Spiral Flute & Spiral Point - 4H5H Tolerance



METRIC COARSE				METRIC MEDIUM			
Thread Size	Part No.	Type	Price	Thread Size	Part No.	Type	Price
M2 - 0.4	45028	SP/POINT	74.85				
	45029	SP/FLUTE	74.85				
M2.2 - 0.45	45018	SP/POINT	74.85				
	45019	SP/FLUTE	74.85				
M2.5 - 0.45	45258	SP/POINT	49.08				
	45259	SP/FLUTE	49.08				
M3 - 0.5	45038	SP/POINT	49.08				
	45039	SP/FLUTE	49.08				
M3.5 - 0.6	45358	SP/POINT	42.95				
	45359	SP/FLUTE	42.95				
M4 - 0.7	45048	SP/POINT	42.95				
	45049	SP/FLUTE	42.95				
	45058	SP/POINT	42.95				
M5 - 0.8	45059	SP/FLUTE	42.95				
M6 - 1	45068	SP/POINT	46.63				
	45069	SP/FLUTE	46.63				
M8 - 1.25	45088	SP/POINT	50.31	M8 - 1	47088	SP/POINT	49.08
	45089	SP/FLUTE	50.31		47089	SP/FLUTE	49.08
M10 - 1.5	45108	SP/POINT	55.22	M10 - 1.25	47108	SP/POINT	61.35
	45109	SP/FLUTE	55.22		47109	SP/FLUTE	61.35
M12 - 1.75	45128	SP/POINT	79.76	M12 - 1.5	47128 ▲	SP/POINT	85.89
	45129	SP/FLUTE	79.76		47129	SP/FLUTE	85.89
M14 - 2	45148	SP/POINT	98.16	M14 - 1.5	47148	SP/POINT	110.43
	45149	SP/FLUTE	98.16		47149	SP/FLUTE	110.43
M16 - 2	45168	SP/POINT	110.43	M16 - 1.5	47168	SP/POINT	122.70
	45169	SP/FLUTE	110.43		47169	SP/FLUTE	122.70
M18 - 2.5	45188	SP/POINT	220.86				
	45189	SP/FLUTE	220.86				
M20 - 2.5	45208	SP/POINT	196.32				
	45209	SP/FLUTE	196.32				
M24 - 3	45248	SP/POINT	233.13				
	45249	SP/FLUTE	233.13				

▲ Denotes non-popular parts - Price On Application. Minimum quantities and order values may apply.

Taps - Straight Flute Taps (Hand/Short Machine)

Inch- ISO British Dimensions, ANSI / BS Dimensions, Other Sizes HSS Material - 3B Tolerance



UNC				BSW				UNF			
Thread Size	Part No.	Type	Price	Thread Size	Part No.	Type	Price	Thread Size	Part No.	Type	Price
#2 - 56	43524	TAPER	39.26	1/8 - 40	42024 ▲	TAPER	61.35	#3 - 56	44534 ▲	TAPER	61.35
	43525	INTER	39.26		42025	INTER	61.35		44535	INTER	61.35
	43526	BOTT	39.26		42026 ▲	BOTT	61.35		44536 ▲	BOTT	61.35
#3 - 48	43534 ▲	TAPER	61.35					#4 - 48	44544 ▲	TAPER	61.35
	43535	INTER	61.35						44545	INTER	61.35
	43536 ▲	BOTT	61.35						44546 ▲	BOTT	61.35
#4 - 40	43544	TAPER	39.26								
	43545	INTER	39.26								
	43546	BOTT	39.26								
#5 - 40	43554	TAPER	42.95								
	43555	INTER	42.95								
	43556	BOTT	42.95								
#6 - 32	43564	TAPER	34.36					#6 - 40	44564 ▲	TAPER	61.35
	43565	INTER	34.36						44565	INTER	61.35
	43566	BOTT	34.36						44566 ▲	BOTT	61.35
#8 - 32	43584	TAPER	36.81					#8 - 36	44584 ▲	TAPER	61.35
	43585	INTER	36.81						44585	INTER	61.35
	43586	BOTT	36.81						44586 ▲	BOTT	61.35
#10 - 24	43604	TAPER	36.81	3/16 - 24	42034	TAPER	42.95	#10 - 32	44604	TAPER	36.81
	43605	INTER	36.81		42035	INTER	42.95		44605	INTER	36.81
	43606	BOTT	36.81		42036	BOTT	42.95		44606	BOTT	36.81
#12 - 24	43624	TAPER	39.26					#12 - 28	44624 ▲	TAPER	42.95
	43625	INTER	39.26						44625	INTER	42.95
	43626	BOTT	39.26						44626 ▲	BOTT	42.95
1/4 - 20	43044	TAPER	36.81	1/4 - 20	42044	TAPER	40.49	1/4 - 28	44044	TAPER	36.81
	43045	INTER	36.81		42045	INTER	40.49		44045	INTER	36.81
	43046	BOTT	36.81		42046	BOTT	40.49		44046	BOTT	36.81
5/16 - 18	43054	TAPER	40.49	5/16 - 18	42054	TAPER	42.95	5/16 - 24	44054	TAPER	40.49
	43055	INTER	40.49		42055	INTER	42.95		44055	INTER	40.49
	43056	BOTT	40.49		42056	BOTT	42.95		44056	BOTT	40.49
3/8 - 16	43064	TAPER	44.17	3/8 - 16	42064	TAPER	49.08	3/8 - 24	44064	TAPER	44.17
	43065	INTER	44.17		42065	INTER	49.08		44065	INTER	44.17
	43066	BOTT	44.17		42066	BOTT	49.08		44066	BOTT	44.17
7/16 - 14	43074	TAPER	58.90	7/16 - 14	42074	TAPER	63.81	7/16 - 20	44074	TAPER	58.90
	43075	INTER	58.90		42075	INTER	63.81		44075	INTER	58.90
	43076	BOTT	58.90		42076	BOTT	63.81		44076	BOTT	58.90
1/2 - 13	43084	TAPER	66.26	1/2 - 12	42084	TAPER	71.17	1/2 - 20	44084	TAPER	66.26
	43085	INTER	66.26		42085	INTER	71.17		44085	INTER	66.26
	43086	BOTT	66.26		42086	BOTT	71.17		44086	BOTT	66.26
9/16 - 12	43094	TAPER	79.76	9/16 - 12	42094 ▲	TAPER	92.03	9/16 - 18	44094	TAPER	79.76
	43095	INTER	79.76		42095	INTER	92.03		44095	INTER	79.76
	43096	BOTT	79.76		42096 ▲	BOTT	92.03		44096	BOTT	79.76
5/8 - 11	43104	TAPER	92.03	5/8 - 11	42104 ▲	TAPER	104.30	5/8 - 18	44104	TAPER	92.03
	43105	INTER	92.03		42105	INTER	104.30		44105	INTER	92.03
	43106	BOTT	92.03		42106 ▲	BOTT	104.30		44106	BOTT	92.03
11/16 - 11	43114 ▲	TAPER	202.46								
	43115	INTER	202.46								
	43116 ▲	BOTT	202.46								
3/4 - 10	43124	TAPER	141.11	3/4 - 10	42124 ▲	TAPER	153.38	3/4 - 16	44124	TAPER	141.11
	43125	INTER	141.11		42125 ▲	INTER	153.38		44125	INTER	141.11
	43126	BOTT	141.11		42126 ▲	BOTT	153.38		44126	BOTT	141.11
7/8 - 9	43144	TAPER	177.92	7/8 - 9	42144 ▲	TAPER	190.19	7/8 - 14	44144 ▲	TAPER	177.92
	43145	INTER	177.92		42145	INTER	190.19		44145	INTER	177.92
	43146	BOTT	177.92		42146 ▲	BOTT	190.19		44146 ▲	BOTT	177.92

Australian Price List Effective July 2013
All prices are exclusive of GST

▲ Denotes non-popular parts - Price On Application.
Minimum quantities and order values may apply.

Taps - Straight Flute Taps (Hand/Short Machine)

Inch - ISO British Dimensions, ANSI / BS Dimensions, Other Sizes HSS Material - 3B Tolerance



UNC				BSW				UNF			
Thread Size	Part No.	Type	Price	Thread Size	Part No.	TYPE	Price	Thread Size	Part No.	TYPE	Price
1" - 8	43164 ▲	TAPER	220.86	1" - 8	42164 ▲	TAPER	245.40	1" - 12	44164 ▲	TAPER	220.86
	43165	INTER	220.86		42165	INTER	245.40		44165	INTER	220.86
	43166	BOTT	220.86		42166 ▲	BOTT	245.40		44166 ▲	BOTT	220.86
1 1/8 - 7	43184 ▲	TAPER	306.76	1 1/8 - 7	42184 ▲	TAPER	331.30	1" - 14	44164-14 ▲	TAPER	233.13
	43185	INTER	306.76		42185	INTER	331.30		44165-14	INTER	233.13
	43186 ▲	BOTT	306.76		42186 ▲	BOTT	331.30		44166-14 ▲	BOTT	233.13
1 1/4 - 7	43204	TAPER	368.11	1 1/4 - 7	42204 ▲	TAPER	404.92	1 1/8 - 12	44184 ▲	TAPER	306.76
	43205	INTER	368.11		42205	INTER	404.92		44185	INTER	306.76
	43206	BOTT	368.11		42206 ▲	BOTT	404.92		44186 ▲	BOTT	306.76
1 3/8 - 6	43224	TAPER	404.92	1 3/8 - 6	42224 ▲	TAPER	429.46	1 1/4 - 12	44204 ▲	TAPER	368.11
	43225	INTER	404.92		42225	INTER	429.46		44205	INTER	368.11
	43226	BOTT	404.92		42226 ▲	BOTT	429.46		44206 ▲	BOTT	368.11
1 1/2 - 6	43244	TAPER	527.62	1 1/2 - 6	42244 ▲	TAPER	552.16	1 3/8 - 12	44224 ▲	TAPER	429.46
	43245	INTER	527.62		42245	INTER	552.16		44225	INTER	429.46
	43246	BOTT	527.62		42246 ▲	BOTT	552.16		44226 ▲	BOTT	429.46
1 1/2 - 6	43244	TAPER	527.62	1 1/2 - 6	42244 ▲	TAPER	552.16	1 1/2 - 12	44244 ▲	TAPER	527.62
	43245	INTER	527.62		42245	INTER	552.16		44245	INTER	527.62
	43246	BOTT	527.62		42246 ▲	BOTT	552.16		44246 ▲	BOTT	527.62

UNC	Thread Size	Part No.	Type	Price
#2 - 56		43528 ▲	SP/POINT	46.63
		43529	SP/FLUTE	46.63
#3 - 48		43538 ▲	SP/POINT	73.62
		43539	SP/FLUTE	73.62
#4 - 40		43548 ▲	SP/POINT	46.63
		43549	SP/FLUTE	46.63
#5 - 40		43558 ▲	SP/POINT	49.08
		43559	SP/FLUTE	49.08
#6 - 32		43568 ▲	SP/POINT	42.95
		43569	SP/FLUTE	42.95
#8 - 32		43588 ▲	SP/POINT	42.95
		43589	SP/FLUTE	42.95
#10 - 24		43608 ▲	SP/POINT	42.95
		43609	SP/FLUTE	42.95
#12 - 24		43628 ▲	SP/POINT	49.08
		43629	SP/FLUTE	49.08
1/4 - 20		43048 ▲	SP/POINT	46.63
		43049	SP/FLUTE	46.63
5/16 - 18		43058 ▲	SP/POINT	49.08
		43059	SP/FLUTE	49.08
3/8 - 16		43068 ▲	SP/POINT	55.22
		43069	SP/FLUTE	55.22
7/16 - 14		43078 ▲	SP/POINT	73.62
		43079	SP/FLUTE	73.62
1/2 - 13		43088 ▲	SP/POINT	82.21
		43089	SP/FLUTE	82.21
5/8 - 11		43108 ▲	SP/POINT	110.43
		43109	SP/FLUTE	110.43
3/4 - 10		43128 ▲	SP/POINT	177.92
		43129	SP/FLUTE	177.92
7/8 - 9		43148 ▲	SP/POINT	220.86
		43149	SP/FLUTE	220.86
1" - 8		43168 ▲	SP/POINT	306.76
		43169 ▲	SP/FLUTE	306.76

UNF	Thread Size	Part No.	Type	Price
#4 - 48		44548 ▲	SP/POINT	73.62
		44549 ▲	SP/FLUTE	73.62
#6 - 40		44568 ▲	SP/POINT	73.62
		44569 ▲	SP/FLUTE	73.62
#8 - 36		44588 ▲	SP/POINT	73.62
		44589 ▲	SP/FLUTE	73.62
#10 - 32		44608 ▲	SP/POINT	42.95
		44609	SP/FLUTE	42.95
1/4 - 28		44048 ▲	SP/POINT	46.63
		44049	SP/FLUTE	46.63
5/16 - 24		44058	SP/POINT	49.08
		44059	SP/FLUTE	49.08
3/8 - 24		44068 ▲	SP/POINT	55.22
		44069	SP/FLUTE	55.22
7/16 - 20		44078 ▲	SP/POINT	73.62
		44079	SP/FLUTE	73.62
1/2 - 20		44088 ▲	SP/POINT	82.21
		44089	SP/FLUTE	82.21
5/8 - 18		44108 ▲	SP/POINT	110.43
		44109	SP/FLUTE	110.43
3/4 - 16		44128 ▲	SP/POINT	177.92
		44129	SP/FLUTE	177.92

▲ Denotes non-popular parts - Price On Application. Minimum quantities and order values may apply.

Australian Price List Effective July 2013
All prices are exclusive of GST

Taps - Straight Flute Taps (Hand/Short Machine)

Inch - ISO British Dimensions, ANSI / BS Dimensions, BA Dimensions, Other Sizes, HSS Material - 3B Tolerance



BSF			
Thread Size	Part No.	Type	Price
3/16 - 32	40034 ▲	TAPER	55.22
	40035	INTER	55.22
	40036	BOTT	55.22
1/4 - 26	40044 ▲	TAPER	55.22
	40045	INTER	55.22
	40046	BOTT	55.22
5/16 - 22	40054 ▲	TAPER	58.90
	40055	INTER	58.90
	40056 ▲	BOTT	58.90
3/8 - 20	40064 ▲	TAPER	67.49
	40065	INTER	67.49
	40066 ▲	BOTT	67.49
7/16 - 18	40074 ▲	TAPER	92.03
	40075	INTER	92.03
	40076 ▲	BOTT	92.03
1/2 - 16	40084 ▲	TAPER	98.16
	40085	INTER	98.16
	40086 ▲	BOTT	98.16
9/16 - 16	40094 ▲	TAPER	110.43
	40095	INTER	110.43
	40096 ▲	BOTT	110.43
5/8 - 14	40104 ▲	TAPER	134.97
	40105	INTER	134.97
	40106 ▲	BOTT	134.97
3/4 - 12	40124 ▲	TAPER	208.59
	40125 ▲	INTER	208.59
	40126 ▲	BOTT	208.59
7/8 - 11	40144 ▲	TAPER	227.00
	40145	INTER	227.00
	40146 ▲	BOTT	227.00
1" - 10	40164 ▲	TAPER	312.89
	40165	INTER	312.89
	40166 ▲	BOTT	312.89
1 1/4 - 9	40204 ▲	TAPER	525.21
	40205	INTER	525.21
	40206 ▲	BOTT	525.21

BA			
Thread Size	Part No.	Type	Price
0 BA	40504 ▲	TAPER	73.62
	40505	INTER	73.62
	40506	BOTT	73.62
2 BA	40524	TAPER	73.62
	40525	INTER	73.62
	40526	BOTT	73.62
4 BA	40544	TAPER	73.62
	40545	INTER	73.62
	40546	BOTT	73.62
6 BA	40564	TAPER	73.62
	40565	INTER	73.62
	40566	BOTT	73.62

SPECIAL SIZES			
Thread Size	Part No.	Type	Price
UNEF 1/4 - 32	44044-32	TAPER	61.35
	44045-32	INTER	61.35
	44046-32	BOTT	61.35
HARLEY 1/4 - 24	44044-24▲	TAPER	61.35
	44045-24	INTER	61.35
	44046-24	BOTT	61.35
HARLEY 7/16 - 16	44074-16	TAPER	98.16
	44075-16	INTER	98.16
	44076-16	BOTT	98.16
CARB. 7/8 - 20	44144-20	TAPER	269.94
	44145-20	INTER	269.94
	44146-20	BOTT	269.94
CARB. 1 - 20	44164-20▲	TAPER	319.03
	44165-20	INTER	319.03
	44166-20	BOTT	319.03
CUMMINS 11/16 - 16	44114-16	TAPER	220.86
	44115-16	INTER	220.86
	44116-16▲	BOTT	220.86

BSP			
Thread Size	Part No.	Type	Price
1/8 - 28	41024 ▲	TAPER	85.89
	41025	INTER	85.89
	41026	BOTT	85.89
1/4 - 19	41044	TAPER	116.57
	41045	INTER	116.57
	41046	BOTT	116.57
3/8 - 19	41064	TAPER	153.38
	41065	INTER	153.38
	41066	BOTT	153.38
1/2 - 14	41084	TAPER	233.13
	41085	INTER	233.13
	41086	BOTT	233.13
5/8 - 14	41104	TAPER	269.94
	41105	INTER	269.94
	41106	BOTT	269.94
3/4 - 14	41124	TAPER	294.49
	41125	INTER	294.49
	41126	BOTT	294.49
1" - 11	41164	TAPER	404.92
	41165	INTER	404.92
	41166	BOTT	404.92

NPT			
Thread Size	Part No.	Type	Price
1/8 - 27	46024 ▲	TAPER	184.05
	46025	INTER	184.05
	46026	BOTT	184.05
1/4 - 18	46044 ▲	TAPER	196.32
	46045	INTER	196.32
	46046	BOTT	196.32
3/8 - 18	46064	TAPER	245.40
	46065	INTER	245.40
	46066	BOTT	245.40
1/2 - 14	46084 ▲	TAPER	306.76
	46085	INTER	306.76
	46086	BOTT	306.76
3/4 - 14	46124 ▲	TAPER	368.11
	46125	INTER	368.11
	46126	BOTT	368.11
1 - 11 1/2	46164 ▲	TAPER	552.16
	46165	INTER	552.16
	46166	BOTT	552.16

BSC			
Thread Size	Part No.	Type	Price
5/16 - 26	46504	TAPER	61.35
	46505	INTER	61.35
	46506	BOTT	61.35
3/8 - 26	46604	TAPER	73.62
	46605	INTER	73.62
	46606 ▲	BOTT	73.62
7/16 - 26	46704 ▲	TAPER	92.03
	46705	INTER	92.03
	46706 ▲	BOTT	92.03
1/2 - 26	46804 ▲	TAPER	110.43
	46805	INTER	110.43
	46806 ▲	BOTT	110.43

8 TPI UN			
Thread Size	Part No.	Type	Price
1 1/8 - 8	46184 ▲	TAPER	368.11
	46185	INTER	368.11
	46186 ▲	BOTT	368.11
1 1/4 - 8	46204	TAPER	429.46
	46205	INTER	429.46
	46206	BOTT	429.46
1 3/8 - 8	46224 ▲	TAPER	552.16
	46225	INTER	552.16
	46226 ▲	BOTT	552.16
1 1/2 - 8	46244	TAPER	429.46
	46245	INTER	429.46
	46246	BOTT	429.46

8 TPI UN			
Thread Size	Part No.	Type	Price
1 5/8 - 8	46264	TAPER	662.59
	46265	INTER	662.59
	46266 ▲	BOTT	662.59
1 3/4 - 8	46284	TAPER	736.21
	46285	INTER	736.21
	46286	BOTT	736.21
1 7/8 - 8	46304 ▲	TAPER	858.92
	46305	INTER	858.92
	46306	BOTT	858.92
2" - 8	46324 ▲	TAPER	920.27
	46325	INTER	920.27
	46326	BOTT	920.27

Australian Price List Effective July 2013
All prices are exclusive of GST

▲ Denotes non-popular parts - Price On Application.
Minimum quantities and order values may apply.

Tap Coatings - TiN - Titanium Nitride Coating

TiCN - Titanium Carbonitride Coating, TiALN - Titanium Aluminium Nitride Coating



TAP SIZES			TiNite	TiCN	TiALN
INCH	BA	METRIC	Price Nett	Price Nett	Price Nett
#2		M2	3.15	4.71	5.35
#3		M2.5	3.15	4.71	5.35
#4	6BA	M3	3.15	4.71	5.35
#5, 1/8"			3.15	4.71	5.35
#6	4BA	M3.5	3.53	5.34	6.01
#8		M4	3.53	5.34	6.01
#10	2BA	M5	3.53	5.34	6.01
#12			3.53	5.34	6.01
1/4"	0BA	M6	5.65	8.47	9.60
		M7	5.65	8.47	9.60
5/16"		M8	8.47	12.72	14.41
3/8"		M9	8.47	12.72	14.41
		M10	8.47	12.72	14.41
7/16"		M11	8.47	12.72	14.41
		M12	11.30	16.95	19.21
1/2"		M13	11.30	16.95	19.21
9/16"		M14	11.30	16.95	19.21
		M15	11.30	16.95	19.21
5/8"		M16	13.97	20.96	23.75
		M18	13.97	20.96	23.75
3/4"			22.52	33.81	38.28
11/16"		M20	22.52	33.81	38.28
7/8"		M22	22.52	33.81	38.28
		M24	22.52	33.81	38.28
1"			22.52	33.81	38.28
		M27	28.02	42.05	47.62
1 1/8"			28.02	42.05	47.62
		M30	28.02	42.05	47.62
1 1/4"			28.02	42.05	47.62
		M33	28.02	42.05	47.62
1 3/8"			28.02	42.05	47.62
		M36	56.27	84.43	95.65
1 1/2"			56.27	84.43	95.65
		M39	73.77	110.64	125.40
1 5/8"		M42	73.77	110.64	125.43
1 3/4"		M47	112.99	169.49	192.08
1 7/8"		M48	112.99	169.49	192.08
2"		M50	112.99	169.49	192.08

Prices are in addition to tap prices. Add A\$10.00 per batch for handling.
All tap coating prices are nett - no further discount applies.



Taper



Intermediate



Bottoming



Spiral flute



Spiral point

Australian Price List Effective July 2013
All prices are exclusive of GST

Gauges - For Gauging STI Holes

i.e. the tapped hole before the insert is installed



METRIC COARSE 65000+ TOLERANCE				
Size	4H5H	Price	5H MED	Price
M2.0 - 0.4	65024	445.78	65025	445.78
M2.2 - 0.45	65014	POA	65015	POA
M2.5 - 0.45	65254	435.77	65255	435.77
M3 - 0.5	65034	401.36	65035	401.36
M3.5 - 0.6	65354	POA	65355	POA
M4 - 0.7	65044	401.36	65045	401.36
M5 - 0.8	65054	401.36	65055	401.36
M6 - 1	65064	401.36	65065	401.36
M7 - 1	65074	POA	65075	POA
M8 - 1.25	65084	401.36	65085	401.36
M9 - 1.25	65094	POA	65095	POA
M10 - 1.5	65104	470.17	65105	470.17
M11 - 1.5	65114	POA	65115	POA
M12 - 1.75	65124	470.17	65125	470.17
M13 - 1.75	65134	POA	65135	POA
M14 - 2	65144	POA	65145	POA
M15 - 2	65154	POA	65155	POA
M16 - 2	65164	538.97	65165	538.97
M18 - 2.5	65184	POA	65185	POA
M20 - 2.5	65204	POA	65205	POA
M22 - 2.5	65224	POA	65225	POA
M24 - 3	65244	POA	65245	POA
M27 - 3	65274	POA	65275	POA
M30 - 3.5	65304	POA	65305	POA
M30 - 3	65304-3	POA	65305-3	POA
M36 - 4	65364	POA	65365	POA
M39 - 4	65394	POA	65395	POA
M42 - 4.5	65424	POA	65425	POA
M42 - 4	65424-4	POA	65425-4	POA

UNC 63000+ TOLERANCE				
Size	3B CLOSE	Price	2B MEDIUM	Price
#2 - 56	63523	POA	63522	445.78
#3 - 48	63533	POA	63532	POA
#4 - 40	63543	POA	63542	401.36
#5 - 40	63553	POA	63552	POA
#6 - 32	63563	401.36	63562	401.36
#8 - 32	63583	401.36	63582	401.36
#10 - 24	63603	POA	63602	401.36
#12 - 24	63623	POA	63622	POA
1/4 - 20	63043	POA	63042	POA
5/16 - 18	63053	POA	63052	POA
3/8 - 16	63063	POA	63062	401.36
7/16 - 14	63073	POA	63072	POA
1/2 - 13	63083	POA	63082	POA
9/16 - 12	63093	POA	63092	POA
5/8 - 11	63103	POA	63102	POA
11/16 - 11	63113	POA	63112	POA
3/4 - 10	63123	POA	63122	POA
7/8 - 9	63143	POA	63142	POA
1" - 8	63163	POA	63162	POA
1 1/8 - 7	63183	POA	63182	POA
1 1/4 - 7	63203	POA	63202	POA
1 3/8 - 6	63223	POA	63222	POA
1 1/2 - 6	63243	POA	63242	POA

BSC 66500+ TOLERANCE				
Size	CLOSE		MEDIUM	Price
1/4 - 26			60042	POA
5/16 - 26			66502	POA
3/8 - 26			66602	POA
7/16 - 26			66702	POA
1/2 - 26			66802	POA

METRIC MEDIUM 67000+ TOLERANCE				
Size	4H5H		5H MED	Price
M8 - 1	67084	435.76	67085	POA
M9 - 1	67094	POA	67095	POA
M10 - 1.25	67104	POA	67105	POA
M11 - 1.25	67114	POA	67115	POA
M12 - 1.5	67124	POA	67125	POA
M13 - 1.5	67134	POA	67135	POA
M14 - 1.5	67144	POA	67145	540.00
M15 - 1.5	67154	POA	67155	POA
M16 - 1.5	67164	POA	67165	POA
M18 - 2	67184	POA	67185	POA
M20 - 2	67204	POA	67205	POA
M22 - 2	67224	POA	67225	POA
M24 - 2	67244	POA	67245	POA
		POA		POA
M27 - 2	67274	POA	67305	POA
		POA		POA
M30 - 2	67304	POA	67305	POA
M36 - 3	67364	POA	67365	POA
M39 - 3	67394	POA	67395	POA
M42 - 3	67424	POA	67425	POA

UNF 64000+ TOLERANCE				
Size	3B CLOSE	Price	2B MEDIUM	Price
#3 - 56	64533	POA	64532	POA
#4 - 48	64543	POA	64542	POA
#6 - 40	64563	POA	64562	POA
#8 - 36	64583	POA	64582	POA
#10 - 32	64603	401.36	64602	POA
1/4 - 28	64043	POA	64042	401.36
5/16 - 24	64053	POA	64052	401.36
3/8 - 24	64063	POA	64062	401.36
7/16 - 20	64073	POA	64072	POA
1/2 - 20	64083	POA	64082	POA
9/16 - 18	64093	POA	64092	POA
5/8 - 18	64103	POA	64102	POA
3/4 - 16	64123	POA	64122	POA
7/8 - 14	64143	POA	64142	POA
1" - 12	64163	POA	64162	POA
1" - 14	64163-14	POA	64162-14	POA
1 1/8 - 12	64183	POA	64182	POA
1 1/4 - 12	64203	POA	64202	POA
1 3/8 - 12	64223	POA	64222	POA
1 1/2 - 12	64243	POA	64242	POA

Gauges - For Gauging STI Holes

i.e. the tapped hole before the insert is installed



BA 60500+ TOLERANCE				
Size	MEDIUM			Price
0 BA			60502	POA
1 BA			60512	POA
2 BA			60522	POA
4 BA			60542	POA
6 BA			60562	POA

METRIC X-FINE 68000+ TOLERANCE				
Size	4H5H	Price	5H MED	Price
M10 - 1	68104	POA	68105	POA
M11 - 1	68114	POA	68115	POA
M12 - 1.25	68124	POA	68125	POA
M13 - 1.25	68134	POA	68135	POA
M18 - 1.5*	68184	POA	68185	POA
M20 - 1.5	68204	POA	68205	POA
M22 - 1.5	68224	POA	68225	POA
M24 - 1.5	68244	POA	68245	POA
M26 - 1.5	68264	POA	68265	POA
M27 - 1.5	68274	POA	68275	POA
M30 - 1.5	68304	POA	68305	POA
M36 - 1.5	68364	POA	68365	POA
M39 - 2	68394	POA	68395	POA
M42 - 2	68424	POA	68425	POA

* Different to sparkplug

BSP 61000+ TOLERANCE				
Size	MEDIUM ONLY			Price
1/8 - 28			61022	POA
1/4 - 19			61042	POA
3/8 - 19			61062	POA
1/2 - 14			64082	POA
5/8 - 14			61102	POA
3/4 - 14			61122	POA
1" - 11			61162	POA

BSW 62000+ TOLERANCE				
Size	MEDIUM ONLY			Price
1/8 - 40			62022	POA
3/16 - 24			62032	POA
1/4 - 20			62042	POA
5/16 - 18			62052	POA
3/8 - 16			62062	POA
7/16 - 14			62072	POA
1/2 - 12			62082	POA
9/16 - 12			62092	POA
5/8 - 11			62102	POA
3/4 - 10			62122	POA
7/8 - 9			62142	POA
1" - 8			62162	POA
1 1/8 - 7			62182	POA
1 1/4 - 7			62202	POA
1 3/8 - 6			62222	POA
1 1/2 - 6			62242	POA

SPARKPLUG 68000+ TOLERANCE				
Size	4H5H	5H MED	Price	
M10 - 1	68104			POA
M12 - 1.25	68124			POA
M14 - 1.25	68144			POA
M18 - 1.5	68184			POA

8 TPI UN 66100+ TOLERANCE				
Size	3B CLOSE	2BMED	Price	
1 1/8 - 8	66183	66182		POA
1 1/4 - 8	66204	66202		POA
1 3/8 - 8	66223	66222		POA
1 1/2 - 8	66243	66242		POA
1 5/8 - 8	66263	66262		POA
1 3/4 - 8	66283	66282		POA
1 7/8 - 8	66303	66302		POA
2 - 8	66323	66322		POA

NPT 66000+ TOLERANCE				
Size	3B CLOSE	2BMED	Price	
1/8 - 27	66023			POA
1/4 - 18	66043			POA
3/8 - 18	66063			POA
1/2 - 14	66083			POA
3/4 - 14	66123			POA
1 - 1 1/2	66163			POA

BSF 60000+ TOLERANCE				
Size	3B CLOSE	2BMED	Price	
3/16 - 32		60032		POA
1/4 - 26		60042		POA
5/16 - 22		60052		POA
3/8 - 20		60062		POA
7/16 - 18		60072		POA
1/2 - 16		60082		POA
9/16 - 16		60092		POA
5/8 - 14		60102		POA
3/4 - 12		60122		POA
7/8 - 11		60142		POA
1" - 10		60162		POA
1 1/4 - 9		60202		POA

POA - Price On Application - denotes non-popular parts. Minimum quantities and order values may apply.

Australian Price List Effective July 2013

All prices are exclusive of GST

Power Installation Tools



UNC SUIT ARO & NR TOOLS FRONT END ASSEMBLY		
Size	Part No.	Price
#2 - 56	53520	418.41
#4 - 40	M8551-04-15	418.41
#5 - 40	M8851-05-15	418.41
#6 - 32	M8551-06-15	418.41
#8 - 32	M8551-2-15	418.41
#10 - 24	M8551-3-15	418.41
1/4 - 20	M8551-4-15	418.41
5/16 - 18	M8251-5-15	377.92
3/8 - 16	M8251-6-16	418.42
7/16 - 14	M8251-7-15	718.73
1/2 - 13	M8251-8-15	718.73
5/8 - 11	53100	647.87
3/4 - 10	53120	647.87

NR SERIES*		SPARE PARTS FOR FRONT END ASSEMBLY				
NR MOTOR & ADAPTOR		MOTOR - ADAPTOR SIZE NOZZLE		FRONT END ASSEMBLY MANDREL		
Part No.	Price	Size	Part No.	Price	Part No.	Price
NR-HL1409	1,569.05	#2 - 56	53528	290.19	53529	151.84
NR-HL1409	1,569.05	#4 - 40	M8557-04-15	290.19	M8553-04	151.84
NR-HL1409	1,569.05	#5 - 40	M8557-05-15	290.19	M8553-05	151.84
NR-HL1409	1,569.05	#6 - 32	M8557-06-15	290.19	M8553-06	151.84
NR-HL1409	1,569.05	#8 - 32	M8557-2-15	290.19	M8553-2	151.84
NR-HL1409	1,569.05	#10 - 24	M8557-3-15	290.19	M8553-3	151.84
NR-HL1409	1,569.05	1/4 - 20	M8557-4-15	290.19	M8553-4	151.84
NR-HL1410	1,872.75	5/16-18	M8257-5-15	290.19	M8253-5	151.84
NR-HL1410	1,872.75	3/8 - 16	M8257-6-15	290.19	M8253-6	151.84
NR-HL1410	1,872.75	7/16 - 14	M8257-7-15	290.19	M8253-7	151.84
NR-HL1410	1,872.75	1/2 - 13	M8257-8-15	448.78	M8253-8	219.33
NR-HL1410	1,872.75	5/8 - 11	53108	448.78	53109	219.33
NR-HL1410	1,872.75	3/4 - 10	53128	448.78	53129	269.94

UNF	Part No.	Price
#6 - 40	54560	418.41
#10 - 32	M8552-3-15	418.41
1/4 - 28	M8552-4-15	418.41
5/16 - 24	M8252-5-15	418.41
3/8 - 24	54060	418.41
7/16 - 20	M8252-7-15	718.73
1/2 - 20	M8252-8-15	718.73
5/8 - 18	M8252-9	647.87
3/4 - 16	54120	647.87

Part No.	UNF	Part No.	Price	Part No.	Price	
NR-HL1409	1,569.05	#6 - 40	54568	290.19	54569	151.84
NR-HL1409	1,569.05	#10 - 32	M8558-3-15	290.19	M8554-3	151.84
NR-HL1409	1,569.05	1/4 - 28	M8558-4-15	290.19	M8554-4	151.84
NR-HL1410	1,872.75	5/16 - 24	M8258-5-15	290.19	M8254-5	151.84
NR-HL1410	1,872.75	3/8 - 24	54068	290.19	54069	151.84
NR-HL1410	1,872.75	7/16 - 20	M8258-7-15	290.19	M8254-7	151.84
NR-HL1410	1,872.75	1/2 - 20	M8258-8-15	448.78	M8254-8	219.33
NR-HL1410	1,872.75	5/8 - 18	M8258-9	448.78	M8254-9	219.33
NR-HL1410	1,872.75	3/4 - 16	54128	448.78	54129	269.94

METRIC COARSE	Price	
M2.2 - 0.45	55250	418.41
M2.5 - 0.45	55250	418.41
M3 - 0.5	M8751-3-15	418.41
M3.5 - 0.6	M8751-3.5-15	418.41
M4 - 0.7	M8751-4-15	418.41
M5 - 0.8	M8751-5-15	418.41
M6 - 1	M8751-6-15	418.41
M7 - 1	55070	718.73
M8 - 1.25	M8751-8-15	718.73
M10 - 1.5	M8751-10-15	718.73
M12 - 1.75	M8751-12-15	718.73
M16 - 2	55160	749.10

Part No.	Price	METRIC COARSE	Price	Part No.	Price	
NR-HL1409	1,569.05	M2.2 - 0.45	55258	290.19	55259	151.84
NR-HL1409	1,569.05	M2.5 - 0.45	55258	290.19	55259	151.84
NR-HL1409	1,569.05	M3 - 0.5	M8769-3-15	290.19	M8757-3	151.84
NR-HL1409	1,569.05	M3.5 - 0.6	M8769-3.5-15	290.19	M8757-3.5	151.84
NR-HL1409	1,569.05	M4 - 0.7	M8769-4-15	290.19	M8757-4	151.84
NR-HL1409	1,569.05	M5 - 0.8	M8769-5-15	290.19	M8757-5	151.84
NR-HL1409	1,569.05	M6 - 1	M8769-6-15	290.19	M8757-6	151.84
NR-HL1410	1,872.75	M7 - 1	55078	448.78	55079	151.84
NR-HL1410	1,872.75	M8 - 1.25	M8769-8-15	448.78	M8757-8	151.84
NR-HL1410	1,872.75	M10 - 1.5	M8769-10-15	448.78	M8757-10	219.33
NR-HL1410	1,872.75	M12 - 1.75	M8769-12-15	448.78	M8757-12	269.94
NR-HL1410	1,872.75	M16 - 2	55168	448.78	55169	269.94

METRIC FINE	Price	
M8 - 1	57080	718.73
M10 - 1.25	57100	718.73
M12 - 1.25	58120	749.10
M12 - 1.5	57120	749.10
M14 - 1.5	M8753-14	718.73

Part No.	Price	METRIC FINE	Part No.	Price	Part No.	Price
NR-HL1410	1,872.75	M8 - 1	57088	485.90	57089	151.84
NR-HL1410	1,872.75	M10 - 1.25	57108	485.90	57109	219.33
NR-HL1410	1,872.75	M12 - 1.25	58128	485.90	58129	269.94
NR-HL1410	1,872.75	M12 - 1.5	57128	485.90	57129	269.94
NR-HL1410	1,872.75	M14 - 1.5	M8773-14	485.90	M8774-14	269.94



Pneumatic Power Tool
(Air motor and adaptor)



Front End Assembly including Mandrel
(1 mandrel only in kit)



Electric Power Tool with Mandrel

Power Installation Tools



PNEUMATIC TANG BREAK-OFF TOOLS

Metric Sizes	Inch Sizes	Part No.	Price
M6	1/4-20, 1/4-28	59192	1,000.02
M10	3/8-16, 3/8-24	59252	1,000.02
M12	1/2-12, 1/2-13	59332	1,000.02
M14-1.5		59462	1,000.02

WORK-ARM TOOL HOLDER*

Part No.	Price	
MANUAL - 16" - 38" Length of Reach	56014	2,000.00

Workarm/Tool Holder must be used on M2.5, 2.2 and 2-56 inserts.
 NOTE: Front End Assembly suits up to 2D inserts and up to 1.5D for 3/4", M20.
 Use on locking inserts 5/8", M14 and larger is marginal for power.
 No slot provided for strip feed. All other sizes are generally supplied with strip feed slot.

POWER TOOL "TOOL BOX"

Part No.	Price	
POWER TOOL - TOOL BOX	PTCASE	36.81

Power Tool "Tool Box" - Provides convenient storage for motor, front end assembly and spanners.

MERCHANDISERS

Price	
Merchandisers - Contact AFS customer service or sales representative to discuss your best merchandiser stocking options.	POA



Work-Arm Tool Holder



Merchandisers



Standard Insertion Tools - Tool Fit Chart

EXTRACTING TOOLS			
Metric Sizes	Inch Sizes	Part No.	Price
M3 thru M10	#4 thru 3/8	50002	23.31
M4 thru M24	#6 thru 1"	50003	25.77
M20 thru M39	1 1/8" thru 1 1/2"	50004	61.35
M38 thru M65	1 1/2" thru 2 1/2"	50005	122.70

SPRING LOADED TANG BREAK TOOLS - (FOR RAPID TANG REMOVAL)			
Metric Sizes	Inch Sizes	Part No.	Price
M2, M2.2	#2	59061	128.84
M2.5	#3	59071	128.84
	#4	59081	128.84
M3	#5	59091	128.84
M3.5	#6	59101	128.84
M4	#8	59121	128.84
M5	#10, #12	59141	128.84
M6	1/4"	59181	128.84
M8	5/16"	59241	196.32
M10	3/8"	59291	196.32
M12	1/2"	59331	220.86

MAGNETIC TANG BREAK TOOLS - (MANUAL TANG REMOVAL)						
Metric Sizes	UNC/UNF	BSW/BSF	Special Thread BSC	BA/BSP/NPT	Part No.	Price
M2-0.4	#2-56				59060M	5.91
M2.2-0.45					59060M	5.91
M2.5-0.45	#3-48, #3-56			6BA	59070M	5.91
	#4-40, #4-48				59080M	5.91
M3-0.5	#5-40	1/8-40			59090M	5.91
M3.5-0.6	#6-32, #6-40			4BA	59100M	5.91
M4-0.7	#8-32, #8-36	5/32			59130M	5.91
	#10-24	3/16-24		2BA	59140M	5.91
M5-0.8	#10-32, #12-24, #12-28	3/16-32			59160M	5.91
M6-1	1/4-20, 1/4-28	1/4-20, 1/4-26	1/4-24, 1/4-26	0BA	59190M	5.91
		5/16-18			59200M	5.91
M7-1	5/16-18				59220M	5.91
M8-1, M8-1.25	5/16-24	5/16-22	5/16-26		59250M	5.91
M9-1, M9-1.25, M10-1.5	3/8-16, 3/8-24	3/8-16, 3/8-20			59280M	5.91
M10-1, M10-1.25	7/16-14, 7/16-20		3/8-26	1/8 BSP/NPT	59310M	5.91
M11-1, M11-1.25, M11-1.5		7/16-14, 7/16-18	7/16-16, 7/16-26		59340M	5.91
M12-1.25, M12-1.5, M12-1.75, M12-1	1/2-13, 1/2-20	1/2-12, 1/2-16	1/2-26		59380M	5.91



Extraction Tool



Spring Loaded Tang Break Tool



Magnetic Tang Break Tool

Standard Insertion Tools - Tool Fit Chart



Manual Installation Tool



Square Drive Installation Tool with tap

Metric Sizes	Part No.	Price
M2 - 0.4	50061-20	19.11
M2.2 - 0.45	50061-21	19.11
M 2.5 - 0.45	50069-17	19.11
M3 - 0.5	50089-17	19.11
M3.5 - 0.6	50095-15	19.11
M4 - 0.7	50125-13	19.11
M5 - 0.8	50156-9	13.50
M6 - 1	50188-5	13.50
M7 - 1	50219-4	13.50
M8 - 1, M8 - 1.25	50250-7	13.50
M9 - 1, M 9 - 1.25	50281-5	13.50
M10-1.5, M10 - 1.25	50281-4	13.50
M10 - 1	50313-12	13.50
M11 - 1, M11 - 1.25, M11 - 1.5	50344-4	14.72
M12 - 1, M13 - 1.25, M13 - 1.5, M13 - 1.75	50375-0	15.95
M12 - 1.25, M12 - 1.5, M12 - 1.75	50375-1	15.95
M14 - 1.5, M14 - 2, M15 - 1.5, M15 - 2	50438-0	17.18
M14-1.25	50468-0	17.18
M16 - 1.5, M16 - 2	50500-0	17.18
M18 - 1.5 SP, M18 - 1.5, M18 - 2, M18 - 2.5	50591-0	22.09
M20 - 1.5, M20 - 2, M20 - 2.5	50591-0	22.09
M22 - 1.5, M22 - 2, M22 - 2.5	50688	24.54
M24 - 1.5, M24 - 2, M24 - 3	50750	42.95
M26 - 1.5, M27 - 1.5, M27 - 2, M27 - 3	50875	42.95
M30 - 1.5, M30 - 2, M30 - 3, M30 - 3.5	51000	42.95
M33 - 2, M33 - 3.5	51063	61.35
M36 - 1.5, M36 - 3, M36 - 4	51125	61.35
M39 - 2, M39 - 3, M39 - 4	51250	61.35
M42 - 2, M42 - 3, M42 - 4, M42 - 4.5	51250	61.35
M45 - 3, M45 - 4.5	51250	61.35
M48 - 3, M48 - 4, M48 - 5, M52 - 3, M52 - 5	51500	85.89

UNC/UNF	Part No.	Price
UNC #2-56	50061-17	19.11
UNC #3-48, UNF #3-56	50069-17	19.11
UNC #4-40, UNF #4-48	50077-17	19.11
UNC #5-40,	50089-18	19.11
UNC #6-32	50095-16	19.11
UNF #6-40	50095-17	19.11
UNC #8-32, UNF #8-36	50125-14	19.63
UNC #10-24	50140-11	19.63
UNC #12-24, UNF #12-28	50156-10	13.50
UNF #10-32	50156-11	13.50
UNC 1/4 - 20, UNF 1/4 - 28	50188-10	13.50
UNC 5/16 - 18	50219-8	13.50
UNF 5/16 - 24	50250-8	13.50
UNC 3/8 - 16	50281-4	13.50
UNF 3/8 - 24	50313-6	13.50
UNC 7/16 - 14	50344-3	14.72
UNF 7/16 - 20	50344-4	14.72
UNC 1/2 - 13	50375-2	15.95
UNF 1/2 - 20	50375-3	14.72
UNC 9/16 - 12, UNF 9/16 - 18	50438-0	17.18
UNC 5/8 - 11, UNC 11/16 - 11, UNF 5/8 - 18	50500-0	17.18
UNC 3/4 - 10, UNF 3/4 - 16	50591-0	22.09
UNC 7/8 - 9, UNF 7/8 - 14	50688	24.54

Standard Insertion Tools - Tool Fit Chart

UNC/UNF	Part No.	Price
UNC 1"- 8, UNF 1"- 12, UNF 1"- 14	50750	42.95
UNC 1 1/8" - 7	50875	42.95
UNC 1 1/4"- 7, UNF 1 1/8"- 12	51000	42.95
UNC 1 3/8"- 6, UNF 1 1/4"- 12	51063	61.35
UNC 1 1/2"- 6, UNF 1 3/8"- 12	51125	61.35
UNF 1 1/2"- 12	51250	61.35
UNC 1 1/2 - 6, UNF 1 3/8 - 12	51125	61.35

BA, BSC, BSF, BSP, BSW, NPT & SPECIAL 8 TPI UN - STANDARD INSERTION TOOLS	Part No.	Price
6BA	50077-17	19.11
1/8 - 40	50089-19	19.11
4BA	50095-15	19.11
2BA, 3/16 - 24	50140-9	19.63
3/16 - 32	50156-9	13.50
0BA, BSF 1/4 - 26, BSW 1/4 - 20	50188-5	13.50
BSW 5/16 - 18	50219-8	13.50
BSC 5/16 - 26	50250-4	13.50
BSF 5/16 - 22	50250-5	13.50
BSW 3/8 - 16	50281-4	13.50
BSF 3/8 - 20	50281-5	13.50
BSC 3/8 - 26, BSP 1/8 - 28	50313-5	13.50
BSC 7/16 - 26, BSF 7/16 - 18	50344-4	14.72
BSW 7/16 - 14	50344-1	14.72
BSC 1/2 - 26, BSF 1/2 - 16, BSW 1/2 - 12	50375-1	15.95
BSW 9/16 - 12, BSF 9/16 - 16, BSP 1/4 - 19, NPT 1/4 - 18	50438-0	17.18
BSF 5/8 - 14, BSP 3/8 - 19, NPT 3/8 - 18, 11/16 - 16	50500-0	17.18
BSW 3/4 - 10, BSF 3/4 - 12	50591-0	22.09
BSF 7/8 - 11, BSP 1/2 - 14, BSW 7/8 - 9, NPT 1/2 - 14	50688	24.54
BSF 1"- 10, BSW 1"- 8, 1"- 20	50750	42.95
BSW 1 1/8"- 7, BSP 5/8 - 14, BSW 1 3/8 - 6, NPT 3/4 - 14, UN 1 1/8 - 8	50875	42.95
BSW 1 1/4"- 7, BSF 1 1/4 - 9, UN 1 1/4 - 8	51000	42.95
UN 1 3/8 - 8	51063	61.35
BSP 3/4 - 14, BSW 1 1/2 - 6, NPT 1 1/2	51125	61.35
UN 1 5/8 - 8, UN 1 3/4 - 8	51250	61.35
UN 2 1/2 - 8	52125	250.00



Manual Installation Tool



Square Drive Installation Tool with tap

- Square Drive sizes available up to and including M12 or 1/2".
- Tap Square Drive is only suitable for non-ferrous alloys.

Electric Installation Tools - Tool Fit Chart

Metric Sizes	Part No.	Price
M2 - 0.4	55027	135.53
M2.5 - 0.45	55257	125.10
M3 - 0.5	55037B	62.55
M4 - 0.7	55047B	62.55
M5 - 0.8	55057B	62.55
M6 - 1	55067B	62.55
M8 - 1.25	55087B	62.55
M10-1.5	55107B	62.55
M10 - 1	58107B	62.55
M12 - 1.75	55127B	62.55
M12 - 1.5	58127B	62.55

Inch Sizes	Part No.	Price
UNC #2 - 56	53527B	125.10
UNC #4 - 40	53547B	62.55
UNC #6 - 32	53567B	62.55
UNC #8 - 32	53587B	62.55
UNC #10 - 24	53607B	62.55
UNF #10 - 32	54607B	62.55
UNC 1/4 - 20	53047B	62.55
UNF 1/4 - 28	54047B	62.55
UNC 5/16 - 18	53057B	62.55
UNF 5/16 - 24	54057B	62.55
UNC 3/8 - 16	53067B	62.55
UNF 3/8 - 24	54067B	62.55
UNC 7/16 - 14	53077B	62.55
UNF 7/16 - 20	54077B	62.55
UNC 1/2 - 13	53087B	62.55
UNF 1/2 - 20	54087B	62.55



Electric Mandrel

Power Installation Tools - Tool Fit Chart

LIGHTWEIGHT DESIGN			
Size	Type	Part No.	Price
M6 - 1	LIGHTWEIGHT DESIGN	55062U	86.01
M8 - 1.25	LIGHTWEIGHT DESIGN	55082U	86.01
M10 - 1.25	LIGHTWEIGHT DESIGN	57102U	86.01
M10 - 1.5	LIGHTWEIGHT DESIGN	55102U	86.01
M12 - 1.5	LIGHTWEIGHT DESIGN	57122U	86.01
M12 - 1.75	LIGHTWEIGHT DESIGN	55122U	86.01
#4 - 40	LIGHTWEIGHT DESIGN	53542U	86.01
#6 - 32	LIGHTWEIGHT DESIGN	53562U	86.01
#8 - 32	LIGHTWEIGHT DESIGN	53582U	86.01
#10 - 24	LIGHTWEIGHT DESIGN	53600U ▲	86.01
1/4 - 20	LIGHTWEIGHT DESIGN	53042U	86.01
5/16 - 18	LIGHTWEIGHT DESIGN	53052U	86.01
3/8 - 16	LIGHTWEIGHT DESIGN	53062U	86.01
7/16 - 14	LIGHTWEIGHT DESIGN	53072U	86.01
1/2 - 13	LIGHTWEIGHT DESIGN	53082U	86.01
#10 - 32	LIGHTWEIGHT DESIGN	54602U	86.01
1/4 - 28	LIGHTWEIGHT DESIGN	54042U	86.01
5/16 - 24	LIGHTWEIGHT DESIGN	54052U	86.01
3/8 - 24	LIGHTWEIGHT DESIGN	54062U	86.01
7/16 - 20	LIGHTWEIGHT DESIGN	54072U	86.01
1/2 - 20	LIGHTWEIGHT DESIGN	54082U	86.01

UNC			
Size	Type	Part No.	Price
#2 - 56	PREWINDER	53521	196.32
#3 - 48	MANDREL	53536	117.79
#4 - 40	PREWINDER	53541	196.32
#5 - 40	PREWINDER	53551	196.32
#6 - 32	PREWINDER	53561	196.32
#8 - 32	PREWINDER	53581	196.32
#10 - 24	PREWINDER	53601	196.32
#12 - 24	PREWINDER	53621	196.32
1/4 - 20	PREWINDER	53041	196.32
5/16 - 18	PREWINDER	53051	215.96
3/8 - 16	PREWINDER	53061	225.77
7/16 - 14	PREWINDER	53071	225.77
1/2 - 13	PREWINDER	53081	245.40
9/16 - 12	MANDREL	53096 ▲	78.53
5/8 - 11	MANDREL	53106	78.53
3/4 - 10	MANDREL	53126	88.35
7/8 - 9	MANDREL	53146	98.16
1" - 8	MANDREL	53166	117.79
1 1/8 - 7	MANDREL	53186 ▲	127.61
1 1/4 - 7	MANDREL	53206 ▲	137.43
1 3/8 - 6	MANDREL	53226 ▲	147.24
1 1/2 - 6	MANDREL	53246 ▲	157.06

METRIC			
Size	Type	Part No.	Price
M2.2 - 0.45	PREWINDER	55011 ▲	294.49
M2.5 - 0.45	PREWINDER	55251	245.40
M3 - 0.5	PREWINDER	55031	245.40
M3.5 - 0.6	PREWINDER	55351 ▲	245.40
M4 - 0.7	PREWINDER	55041	245.40
M5 - 0.8	PREWINDER	55051	245.40
M6 - 1	PREWINDER	55061	245.40
M7 - 1	PREWINDER	55071	245.40
M8 - 1.25	PREWINDER	55081	245.40
M10 - 1.5	PREWINDER	55101	245.40
M12 - 1.75	PREWINDER	55121	245.40
M14 - 2	MANDREL	55146	147.24
M16 - 2	MANDREL	55166	147.24
M18 - 2.5	MANDREL	55186	147.24
M8 - 1	PREWINDER	57081	245.40
M10 - 1	PREWINDER	58101	245.40
M10 - 1.25	PREWINDER	57101	245.40
M12 - 1.25	PREWINDER	58121	245.40
M12 - 1.5	PREWINDER	57121	245.40
M14 - 1.5	NON CAPTIVE	57141	588.97
M16 - 1.5	NON CAPTIVE	57161	638.05
M18 - 1.5	NON CAPTIVE	58181	687.13

UNF			
Size	Type	Part No.	Price
#3 - 56	PREWINDER	54531	215.96
#4 - 48	PREWINDER	54541	215.96
#6 - 40	PREWINDER	54561	215.96
#8 - 36	PREWINDER	54581	215.96
#10 - 32	PREWINDER	54601	215.96
1/4 - 20	PREWINDER	54041	215.96
5/16 - 24	PREWINDER	54051	215.96
3/8 - 24	PREWINDER	54061	215.96
7/16 - 20	PREWINDER	54071	245.40
1/2 - 20	PREWINDER	54081	245.40
9/16 - 18	NON CAPTIVE	54091 ▲	392.65
5/8 - 18	NON CAPTIVE	54101	588.97
3/4 - 16	NON CAPTIVE	54121	883.46
7/8 - 14	NON CAPTIVE	54141	883.46
1" - 14	NON CAPTIVE	54171 ▲	883.46
1" - 12	NON CAPTIVE	54161 ▲	883.46
1 1/8 - 12	NON CAPTIVE	54181	883.46

▲ Denotes non-popular parts - Price On Application. Minimum quantities and order values may apply.

Australian Price List Effective July 2013. All prices are exclusive of GST.



'Prewinder' Non Captive Type Installation Tool



Semi Production 'Pre-Winder' Type Installation Tool - Metal Body



Non-Captive 'Pre-Winder' Type Installation Tool - Aluminium Body

Carbon Steel Bulk Keyserts - Metric

Minimum Pack Quantities apply



LIGHTWEIGHT - METRIC SERIES - CARBON STEEL						KEYSERT PRICE PER EACH				INSTALLATION TOOL	
INTERNAL	EXTERNAL	Length (mm)	Drill Size	Part No.	Min. Qty	*	100+	500+	1000+	Part No.	Price
Thread Size CLASS 6H	Thread Class CLASS 6G										
M5 - 0.8	M8 - 1.25	8	6.9	75051	5	7.61	6.09	5.48	5.20	72190	40.66
M6 - 1	M10 - 1.25	10	8.8	75061	5	8.45	6.77	6.09	5.78	72250	41.95
M8 - 1.25	M12 - 1.25	12	10.8	75081	5	9.31	7.44	6.70	6.37	72312	43.58
M8 - 1	M12 - 1.25	12	10.8	77081	5	9.31	7.44	6.70	6.37	72312	43.58
M10 - 1.5	M14 - 1.5	14	12.8	75101	4	11.45	9.15	8.25	7.82	72375	46.82
M10 - 1.25	M14 - 1.5	14	12.8	77101	4	11.45	9.15	8.25	7.82	72375	46.82
M12 - 1.75	M16 - 1.5	16	14.75	75121	4	14.77	11.81	10.63	10.10	72500	53.21
M12 - 1.25	M16 - 1.5	16	14.75	78121	4	14.77	11.81	10.63	10.10	72500	53.21

HEAVY DUTY - METRIC SERIES - CARBON STEEL						KEYSERT PRICE PER EACH				INSTALLATION TOOL	
Internal	External	Length (mm)	Drill Size	Part No.	Min. Qty	*	100+	500+	1000+	Part No.	Price
Thread Size	Thread Size										
M4 - 0.7	M8 - 1.25	8	6.9	75042	3	15.09	12.07	10.86	10.32	71042	65.03
M5 - 0.8	M10 - 1.25	10	8.8	75052	5	7.61	6.09	5.48	5.20	72190	40.66
M6 - 1	M12 - 1.25	12	10.8	75062	5	8.45	6.77	6.09	5.78	72250	41.95
M8 - 1.25	M14 - 1.5	14	12.8	75082	5	9.31	7.44	6.70	6.37	72312	43.58
M8 - 1	M14 - 1.5	14	12.8	77082	5	9.31	7.44	6.70	6.37	72312	43.58
M10 - 1.5	M16 - 1.5	16	14.75	75102	4	11.45	9.15	8.25	7.82	72375	46.82
M10 - 1.25	M16 - 1.5	16	14.75	77102	4	11.45	9.15	8.25	7.82	72375	46.82
M12 - 1.75	M18 - 1.5	18	16.75	75122	4	14.77	11.81	10.63	10.10	72500	53.21
M12 - 1.25	M18 - 1.5	18	16.75	78122	4	14.77	11.81	10.63	10.10	72500	53.21
M14 - 2	M20 - 1.5	20	18.75	75142	3	17.82	14.25	12.83	12.19	72500	53.21
M14 - 1.5	M20 - 1.5	20	18.75	77142	3	17.82	14.25	12.83	12.19	72500	53.21
M16 - 2	M22 - 1.5	22	20.5	75162	2	21.14	16.91	15.22	14.47	72625	56.91
M16 - 1.5	M22 - 1.5	22	20.5	77162	2	21.14	16.91	15.22	14.47	72625	56.91
M18 - 1.5	M24 - 1.5	24	22.5	78182	1	31.55	25.23	22.71	21.58	71182▲	56.91
M20 - 2.5	M30 - 2	30	28	75202	1	36.94	29.54			72875	60.30
M20 - 1.5	M30 - 2	30	28	78202	1	36.94	29.54			72875	60.30
M22 - 1.5	M32 - 2	32	30	78222	1	44.61	35.68			72875	60.30
M24 - 3	M33 - 2	33	31	75242	1	59.83	47.86			71242	82.76
M24 - 2			31	77242	1	59.83	47.86			71242	82.76

SOLID - METRIC - CARBON STEEL					
EXTERNAL	Length (mm)	Drill Size	Part No.	Min. Qty	Price
Thread Class CLASS 6G					
M8 - 1.25	8	6.9	75084▲	1	37.53
M10 - 1.25	10	8.8	77104▲	1	39.54
M12 - 1.25	12	10.8	78124▲	1	42.21
M14 - 1.5	14	12.8	77144▲	1	52.74
M16 - 1.5	16	14.75	77164▲	1	58.66
M18 - 1.5	18	16.75	78184▲	1	65.88
M20 - 1.5	20	18.75	78204▲	1	73.36
M22 - 1.5	22	20.5	78224▲	1	108.99
M24 - 2	24	22.5	78244▲	1	108.99
M30 - 2	30	28	77304▲	1	116.67
M32 - 2	32	30	77322▲	1	122.26
M33 - 2	33	31	77332▲	1	131.18

▲ Denotes non-popular parts - Price On Application.
Minimum quantities and order values may apply.

* Refer to Minimum Quantity

Carbon Steel Bulk Keyserts - Inch

Minimum Pack Quantities Apply



LIGHTWEIGHT - INCH SERIES - CARBON STEEL				KEYSERT PRICE PER EACH						INSTALLATION TOOL	
INTERNAL Thread Size Class 2B	EXTERNAL Thread Class 2A (MOD)	Length (mm)	Drill Size	Part No.	Min. Qty	*	100+	500+	1000+	Part No.	Price
#10-24	5/16-18	0.31	I (.2720")	73601	8	4.88	3.90	3.51	3.34	72190	40.66
#10-32	5/16-18	0.31	I (.2720")	74601	8	4.88	3.90	3.51	3.34	72190	40.66
1/4-20	3/8-16	0.37	Q (.3320")	73041	7	5.14	4.11	3.70	3.52	72250	41.95
1/4-28	3/8-16	0.37	Q (.3320")	74041	7	5.14	4.11	3.70	3.52	72250	41.95
5/16-18	7/16-14	0.43	X (.3970")	73051	7	5.79	4.63	4.18	3.95	72312	43.58
5/16-24	7/16-14	0.43	X (.3970")	74051	7	5.79	4.63	4.18	3.95	72312	43.58
3/8-16	1/2-13	0.50	29/64	73061	7	6.37	5.09	4.59	4.37	72375	46.82
3/8-24	1/2-13	0.50	29/64	74061	7	6.37	5.09	4.59	4.37	72375	46.82
7/16-14	9/16-12	0.56	33/64	73071	7	8.27	6.61	5.95	5.65	72375	46.82
7/16-20	9/16-12	0.56	33/64	74071	7	8.27	6.61	5.95	5.65	72375	46.82
1/2-13	5/8-11	0.62	37/64	73081	7	9.57	7.65	6.88	6.55	72500	53.21
1/2-20	5/8-11	0.62	37/64	74081	7	9.57	7.65	6.88	6.55	72500	53.21

HEAVY DUTY - INCH SERIES - CARBON STEEL				Part No.	Min. Qty	*	100+	500+	1000+	Part No.	Price
#8-32	5/16-18	0.31	I (.272")	73582	7	8.13	6.50	5.86	5.57	70582	148.04
#10-24	3/8-16	0.31	Q (.332")	73602	8	4.88	3.90	3.51	3.34	72190	40.66
#10-32	3/8-16	0.31	Q (.332")	74602	8	4.88	3.90	3.51	3.34	72190	40.66
1/4-20	7/16-14	0.37	X (.397")	73042	7	5.14	4.11	3.70	3.52	72250	41.95
1/4-28	7/16-14	0.37	X (.397")	74042	7	5.14	4.11	3.70	3.52	72250	41.95
5/16-18	1/2-13	0.43	29/64	73052	7	5.72	4.57	4.11	3.91	72312	43.58
5/16-24	1/2-13	0.43	29/64	74052	7	5.72	4.57	4.11	3.91	72312	43.58
3/8-16	9/16-12	0.50	33/64	73062	7	6.37	5.09	4.59	4.37	72375	46.82
3/8-24	9/16-12	0.50	33/64	74062	7	6.37	5.09	4.59	4.37	72375	46.82
7/16-14	5/8-11	0.62	37/64	73072	7	8.13	6.51	5.86	5.57	72375	46.82
7/16-20	5/8-11	0.62	37/64	74072	7	8.13	6.51	5.86	5.57	72375	46.82
1/2-13	3/4-16	0.62	45/64	73082	7	9.57	7.65	6.88	6.55	72500	53.21
1/2-20	3/4-16	0.62	45/64	74082	7	9.57	7.65	6.88	6.55	72500	53.21
9/16-12	3/4-16	0.81	45/64	73092	4	13.08	10.46	9.41	8.96	72500	53.21
9/16-18	3/4-16	0.81	45/64	74092	4	13.08	10.46	9.41	8.96	72500	53.21
5/8-11	7/8-14	0.87	53/64	73102	3	15.42	12.66	11.11	10.54	72625	56.91
5/8-18	7/8-14	0.87	53/64	74102	3	15.42	12.66	11.11	10.54	72625	56.91
3/4-10	1 1/8-12	1.12	11/16	73122	2	21.98	17.58	15.82	15.04	72875	60.30
3/4-16	1 1/8-12	1.12	11/16	74122	2	21.98	17.58	15.82	15.04	72875	60.30
7/8-9	1 1/4-12	1.25	13/16	73142	1	28.74	23.00	20.70	19.66	72875	60.30
7/8-14	1 1/4-12	1.25	13/16	74142	1	28.74	23.00	20.70	19.66	72875	60.30
1"-8	1 3/8-12	1.37	15/16	73162	1	58.27	46.61	41.95	39.85	72100	73.62
1"-12	1 3/8-12	1.37	15/16	74162	1	58.27	46.61	41.95	39.85	72100	73.62
1"-14	1 3/8-12	1.37	15/16	74162-14	1	58.27	46.61	41.95	39.85	70162▲	117.80
1 1/8-7	1/12-12	1.62	17/16	73182▲	1	140.47	112.37			70182▲	273.14
1 1/8-12	1/12-12	1.62	17/16	74182	1	140.47	112.37			70182▲	273.14
1 1/4-7	1 5/8-12	1.81	19/16	73202▲	1	172.53	138.03			70202	295.03
1 1/4-12	1 5/8-12	1.81	16/16	74202	1	172.53	138.03			70202	295.03
1 1/2-6	1 7/8-12	2.00	1 13/16	73242	1	332.18				70242▲	295.03
1 1/2-12	1 7/8-12	2.00	1 13/16	74242▲	1	332.18				70242▲	295.03

SOLID - METRIC - CARBON STEEL			KEYSERT PRICE PER EACH			
EXTERNAL Thread Class 2B	Length (mm)	Drill Size	Part No.	Min. Qty	Price	
5/16-18	0.31	I (.272")	73054▲	1	36.10	
3/8-16	0.31	Q (.332")	73064▲	1	37.98	
7/16-14	0.37	X (.397")	73074▲	1	40.44	
1/2-13	0.43	29/64	73084▲	1	50.92	
9/16-12	0.5	33/64	73094▲	1	56.65	
5/8-11	0.62	37/64	73104▲	1	63.80	
3/4-16	0.68	45/64	73124▲	1	71.28	
7/8-14	0.87	53/64	73144▲	1	81.81	
1 - 12	0.87	15/16	74164▲	1	107.17	
1 1/8 - 12	1.12	1 1/16	74184▲	1	114.79	
1 1/4 - 12	1.25	1 3/16	74204▲	1	120.51	
1 3/8 - 12	1.37	1 5/16	74224▲	1	129.41	

▲ Denotes non-popular parts - Price On Application.
Minimum quantities and order values may apply.

* Refer to Minimum Quantity

Australian Price List Effective July 2013
All prices are exclusive of GST

Stainless Steel Bulk Keyserts

Minimum Pack Quantities Apply



LIGHTWEIGHT - METRIC SERIES - STAINLESS STEEL											
INTERNAL		EXTERNAL		KEYSERTE PRICE PER EACH						INSTALLATION TOOL	
Thread Class 6H	Thread Class 6G	Length (mm)	Drill Size	Part No.	Min. Qty	*	100+	500+	1000+	Part No.	Price
M5 - 0.8	M8 - 1.25	8	6.9	75056	2	16.32	13.87	11.79	10.61	72190	40.66
M6 - 1	M10 - 1.25	10	8.8	75066	2	16.87	14.34	12.19	10.98	72250	41.95
M8 - 1.25	M12 - 1.25	12	10.8	75086	2	17.38	14.79	12.55	11.30	72312	43.58
M8 - 1	M12 - 1.25	12	10.8	77086	2	17.38	14.79	12.55	11.30	72312	43.58
M10 - 1.5	M14 - 1.5	14	12.8	75106	2	17.90	15.22	12.94	11.63	72375	46.82
M10 - 1.25	M14 - 1.5	14	12.8	77106	2	17.90	15.22	12.94	11.63	72375	46.82
M12 - 1.75	M16 - 1.5	16	14.75	75126	2	19.89	16.91	14.37	12.94	72500	53.21
M12 - 1.25	M16 - 1.5	16	14.75	78126	2	19.89	16.91	14.37	12.94	72500	53.21

HEAVY DUTY - METRIC SERIES - STAINLESS STEEL											
INTERNAL		EXTERNAL		KEYSERTE PRICE PER EACH						INSTALLATION TOOL	
Thread Class 6H	Thread Class 6G	Length (mm)	Drill Size	Part No.	Min. Qty	*	100+	500+	1000+	Part No.	Price
M4 - 0.7	M8 - 1.25	8	6.9	75047	2	20.27	17.23	14.64	13.18	71042	65.03
M5 - 0.8	M10 - 1.25	10	8.8	75057	2	20.72	17.60	14.97	13.47	72250	41.95
M6 - 1	M12 - 1.25	12	10.8	75067	2	21.84	18.56	15.77	14.20	72250	41.95
M8 - 1.25	M14 - 1.5	14	12.8	75087	2	22.97	19.54	16.60	14.93	72312	43.58
M8 - 1	M14 - 1.5	14	12.8	77087	2	22.97	19.54	16.60	14.93	72312	43.58
M10 - 1.5	M16 - 1.5	16	14.75	75107	2	24.11	20.49	17.42	15.68	72375	46.82
M10 - 1.25	M16 - 1.5	16	14.75	77107▲	2	24.11	20.49	17.42	15.68	72375	46.82
M12 - 1.75	M18 - 1.5	18	16.75	75127	2	25.23	21.45	18.23	16.41	72500	53.21
M12 - 1.25	M18 - 1.5	18	16.75	78127	2	25.23	21.45	18.23	16.41	72500	53.21
M14 - 2	M20 - 1.5	20	18.75	75147▲	1	28.69	24.38	20.73	18.64	72500▲	53.21
M14 - 1.5	M20 - 1.5	20	18.75	77147	1	28.68	24.38	20.73	18.64	72500	53.21
M16 - 2	M22 - 1.5	22	20.5	75167	1	37.17	31.59	26.86	24.17	72625	56.91
M16 - 1.5	M22 - 1.5	22	20.5	77167▲	1	37.17	31.59	26.86	24.17	72625	56.91
M18 - 1.5	M24 - 1.5	24	22.5	78187	1	71.70	60.94	51.80	46.62	71182	POA
M20 - 2.5	M30 - 2	30	28	75207▲	1	71.70	60.94	51.80	46.62	72875	60.30
M20 - 1.5	M30 - 2	30	28	78207	1	71.70	60.94	51.80	46.62	72875	60.30
M22 - 1.5	M32 - 2	32	30	78227	1	77.01	65.46	55.64	50.07	72875	60.30
M24 - 3	M33 - 2	33	31	75247	1	77.01	65.46	55.64	50.07	71242	82.76
M24 - 2	M33 - 2	33	31	77247	1	114.15	97.02	82.47	74.22	71242	82.76

▲ Denotes non-popular parts - Price On Application.
Minimum quantities and order values may apply.

* Refer to Minimum Quantity

Stainless Steel Bulk Keyserts

Minimum Pack Quantities Apply



LIGHT WEIGHT SERIES - STAINLESS STEEL										INSTALLATION TOOL	
INTERNAL	EXTERNAL	Length (mm)	Drill Size	Part No.	Min. Qty	KEYSERTE PRICE PER EACH				Part No.	Price
Thread Class 2B	Thread Class 6G					*	100+	500+	1000+		
#10 - 24	5/16 - 18	0.31	I (.272")	73606	4	8.00	6.41	5.76	5.47	72190	40.66
#10 - 32	5/16 - 18	0.31	I (.272")	74606	4	8.00	6.41	5.76	5.47	72190	40.66
1/4 - 20	3/8 - 16	0.37	Q (.332")	73046	4	8.40	6.72	6.04	5.74	72250	41.95
1/4 - 28	3/8 - 16	0.37	Q (.332")	74046	4	8.40	6.72	6.04	5.74	72250	41.95
5/16 - 18	7/16 - 14	0.43	X (.397")	73056	3	13.73	10.98	9.89	9.39	72312	43.58
5/16 - 24	7/16 - 14	0.43	X (.397")	74056	3	13.73	10.98	9.89	9.39	72312	43.58
3/8 - 16	1/2 - 13	0.50	29/64	73066	3	16.85	13.48	12.13	11.53	72375	46.82
3/8 - 24	1/2 - 13	0.50	29/64	74066	3	16.85	13.48	12.13	11.53	72375	46.82
7/16 - 14	9/16 - 12	0.56	33/64	73076	2	24.91	19.93	17.94	17.04	72375	46.82
7/16 - 20	9/16 - 12	0.56	33/64	74076	2	24.91	19.93	17.94	17.04	72375	46.82
1/2 - 13	5/8 - 11	0.62	37/64	73086	2	26.53	21.23	19.11	18.15	72500	53.21
1/2 - 20	5/8 - 11	0.62	37/64	74086	2	26.53	21.23	19.11	18.15	72500	53.21

HEAVY DUTY - INCH SERIES - STAINLESS STEEL				Part No.	Min. Qty	*	100+	500+	1000+	Part No.	Price
#8 - 32	5/16 - 18	0.31	I (.272")	73587	3	7.61	6.09	5.48	5.20	70582	148.04
#10 - 24	3/8 - 16	0.31	Q (.332")	73607	3	8.40	6.72	6.04	5.74	72190	40.66
#10 - 32	3/8 - 16	0.31	Q (.332")	74607	3	8.40	6.72	6.04	5.74	72190	40.66
1/4 - 20	7/16 - 14	0.37	X (.397")	73047	3	9.10	7.28	6.55	6.23	72250	41.95
1/4 - 28	7/16 - 14	0.37	X (.397")	74047	3	9.10	7.28	6.55	6.23	72250	41.95
5/16 - 18	1/2 - 13	0.43	29/64	73057	2	13.60	10.87	9.79	9.31	72312	43.58
5/16 - 24	1/2 - 13	0.43	29/64	74057	2	13.60	10.87	9.79	9.31	72312	43.58
3/8 - 16	9/16 - 12	0.50	33/64	73067	2	15.87	12.70	11.43	10.85	72375	46.82
3/8 - 24	9/16 - 12	0.50	33/64	74067	2	15.87	12.70	11.43	10.85	72375	46.82
7/16 - 14	5/8 - 11	0.62	37/64	73077	2	23.35	18.69	16.82	15.98	72375	46.82
7/16 - 20	5/8 - 11	0.62	37/64	74077	2	23.35	18.69	16.82	15.98	72375	46.82
1/2 - 13	3/4 - 16	0.62	45/64	73087	2	28.56	22.84	20.57	19.54	72500	53.21
1/2 - 20	3/4 - 16	0.62	45/64	74087	2	28.56	22.84	20.57	19.54	72500	53.21
9/16 - 12	3/4 - 16	0.81	45/64	73097	2	30.30	24.24	21.81	20.74	72500	53.21
9/16 - 18	3/4 - 16	0.81	45/64	74097	2	30.30	24.24	21.81	20.74	72500	53.21
5/8 - 11	7/8 - 14	0.87	53/64	73107	2	38.05	30.43	27.39	26.02	72625	56.91
5/8 - 18	7/8 - 14	0.87	53/64	74107	2	38.05	30.43	27.39	26.02	72625	56.91
3/4 - 10	1 1/8 - 12	1.12	1 1/16	73127	2	44.68	35.75	32.17	30.57	72875	60.30
3/4 - 16	1 1/8 - 12	1.12	1 1/16	74127	2	44.68	35.75	32.17	30.57	72875	60.30
7/8 - 9	1 1/4 - 12	1.25	1 3/16	73147 ▲	1	POA				72875	60.30
7/8 - 14	1 1/4 - 12	1.25	1 3/16	74147 ▲	1	POA				72875	60.30
1" - 8	1 3/8 - 12	1.37	1 5/16	73167 ▲	1	POA				72100	73.62
1" - 12	1 3/8 - 12	1.37	1 5/16	74167 ▲	1	POA				72100	73.62

SOLID - INCH - STAINLESS STEEL						
EXTERNAL	Length (Inch) (Modified)	Drill Size	KEYSERTE PRICE PER EACH			
Thread Class 2B			Part No.	Min. Qty	Price	
5/16 - 18	0.31	I (.272")	73059 ▲	1	POA	
3/8 - 16	0.31	Q (.332")	73069 ▲	1	50.80	
7/16 - 14	0.37	X (.397")	73079 ▲	1	54.67	
1/2 - 13	0.43	37/64	73089 ▲	1	89.74	
9/16 - 12	0.5	45/64	73099 ▲	1	104.00	
5/8 - 11	0.62	53/64	73109 ▲	1	118.18	
3/4 - 16	0.68	1 1/16	73129 ▲	1	167.12	
7/8 - 14	0.87	1 3/16	73149 ▲	1	216.10	
1" - 12	0.87	1 5/16	74169 ▲	1	316.25	
1 1/8 - 12	1.12	1 7/16	74189 ▲	1	353.98	
1 1/4 - 12	1.25	1 9/16	74209 ▲	1	416.34	
1 3/8 - 12	1.37	1 5/16	74229 ▲	1	451.06	

▲ Denotes non-popular parts - Price On Application.

Minimum quantities and order values may apply.

* Refer to Minimum Quantity

Carbon & Stainless Steel Keysert

Replacement Packets



LIGHTWEIGHT - INCH SERIES - CARBON STEEL			
INTERNAL			
Thread Size Class 2B	Part No.	Qty per/pkt	Price /pkt
#10 - 24	73601P	8	39.07
#10 - 32	74601P	8	39.07
1/4 - 20	73041P	7	36.00
1/4 - 28	74041P	7	36.00
5/16 - 18	73051P	7	40.56
5/16 - 24	74051P	7	40.56
3/8 - 16	73061P	7	44.61
3/8 - 24	74061P	7	44.61
7/16 - 14	73071P	7	57.86
7/16 - 20	74071P	7	57.86
1/2 - 13	73081P	7	66.96
1/2 - 20	74081P	7	66.96

LIGHTWEIGHT - METRIC SERIES - CARBON STEEL			
INTERNAL			
Thread Size Class 6H	Part No.	Qty per/pkt	Price /pkt
M5 - 0.8	75051P	5	38.07
M6 - 1	75061P	5	42.27
M8 - 1.25	75081P	5	46.53
M8 - 1	77081P	5	46.53
M10 - 1.5	75101P	4	45.78
M10 - 1.25	77101P	4	45.78
M12 - 1.75	75121P	4	59.07
M12 - 1.25	78121P	4	59.07

STAINLESS STEEL KEYSERT THREAD			
INTERNAL			
Thread Size Class 2B	Part No.	Qty per/pkt	Price /pkt
#10 - 24	73606P	4	32.02
#10 - 32	74606P▲	4	32.02
1/4 - 20	73046P	4	33.58
1/4 - 28	74046P▲	4	33.58
5/16 - 18	73056P	3	41.18
5/16 - 24	74056P	3	41.18
3/8 - 16	73066P	3	50.55
3/8 - 24	74066P▲	3	50.55
7/16 - 14	73076P▲	2	49.83
7/16 - 20	74076P▲	2	49.83
1/2 - 13	73086P	2	53.07
1/2 - 20	74086P▲	2	53.07

LIGHTWEIGHT - METRIC SERIES - STAINLESS STEEL			
INTERNAL			
Thread Size Class 6H	Part No.	Qty per/pkt	Price /pkt
M5 - 0.8	75056P	2	32.63
M6 - 1	75066P	2	33.75
M8 - 1.25	75086P	2	34.76
M8 - 1	77086P▲	2	34.76
M10 - 1.5	75106P	2	35.80
M10 - 1.25	77106P	2	35.80
M12 - 1.75	75126P	2	39.78
M12 - 1.25	78126P▲	2	39.78

▲ Denotes non-popular parts - Price On Application.
Minimum quantities and order values may apply.

The Recoil Tapper System - Metric



302 SERIES							
STANDARD TAPPER FOR METALS, WOOD AND PLASTICS							
STEEL, CASE HARDENED, ZINC PLATED							
Internal Thread Size	External Thread (mm)	Length (mm)	Part No.	PRICE PER EACH			
				10+	100+	1000+	
M3 - 0.5	5	6	3020030.16		0.637	0.573	0.531
M3.5 - 0.6	6	8	3020035.16		0.729	0.655	0.605
M4 - 0.7	6.5	8	3020040.16	*	0.810	0.730	0.676
M5 - 0.8	8	10	3020050.16	*	0.917	0.825	0.764
M6 - 1	9	12	3020061.16	*	1.098	0.989	0.915
M6 - 1	10	14	3020060.16	*	1.215	1.094	1.012
M8 - 1.25	12	15	3020080.16	*	1.610	1.450	1.341
M10 - 1.5	14	18	3020100.16	*	2.406	2.166	2.003
M10 - 1.25	14	18	3020106.16	*	2.406	2.166	2.003
M12 - 1.75	16	22	3020120.16	*	3.375	3.037	2.810
M12 - 1.5	16	22	3020127.16	*	3.375	3.037	2.810
M14 - 2	18	24	3020140.16	*	4.170	3.753	3.472
M16 - 2	20	22	3020160.16	*	5.544	4.988	4.616
M18 - 2.5	22	24	3020180.16		7.741	6.967	6.443
M20 - 2.5	26	27	3020200.16		11.137	10.023	9.271

Note: External Thread - Tolerances (ISO 2768-m) in accordance with Works Standard 302.

302.....40 SERIES							
STANDARD TAPPER FOR METALS, WOOD AND PLASTICS							
STAINLESS STEEL (304)							
Internal Thread	External Thread (mm)	Length (mm)	Part No.	PRICE PER EACH			
				10+	100+	1000+	
M3 - 0.5	5	6	3020030.40		1.279	1.151	1.063
M3.5 - 0.6	6	8	3020035.40		1.471	1.325	1.224
M4 - 0.7	6.5	8	3020040.40		1.630	1.468	1.356
M5 - 0.8	8	10	3020050.40		1.854	1.669	1.543
M6 - 1	9	12	3020061.40		2.213	1.992	1.841
M6 - 1	10	14	3020060.40	*	2.455	2.209	2.044
M8 - 1.25	12	15	3020080.40	*	3.247	2.923	2.704
M10 - 1.5	14	18	3020100.40		4.857	4.369	4.043
M12 - 1.75	16	22	3020120.40		9.751	8.777	8.119
M14 - 2	18	24	3020140.40		11.768	10.591	9.795
M16 - 2	20	22	3020160.40		14.822	13.340	12.338
M18 - 2.5	22	24	3020180.40		18.165	16.347	15.121
M20 - 2.5	26	27	3020200.40		23.611	21.250	19.656

Note: External Thread - Tolerances (ISO 2768-m) in accordance with Works Standard 302.

305 SERIES							
STANDARD TAPPER FOR SOFT THERMO PLASTICS							
BRASS							
Internal Thread	External Thread (mm)	Length (mm)	Part No.	PRICE PER EACH			
				10+	100+	1000+	
M3 - 0.5	5	6	3050030.80	*	0.508	0.458	0.422
M3.5 - 0.6	6	8	3050035.80		0.537	0.484	0.447
M4 - 0.7	6.5	8	3050040.80	*	0.561	0.505	0.467
M5 - 0.8	8	10	3050050.80	*	0.786	0.707	0.655
M6 - 1	10	14	3050060.80		1.051	0.943	0.874

Note: External thread - Tolerances (ISO 2768-m) in accordance with Works Standard 305.

* Sizes normally available ex stock. Lead time and minimums may apply on all other sizes.
 A wider range of sizes and materials available on request. Contact AFS for further information.
 Australian Price List Effective July 2013
 All prices are exclusive of GST

The Recoil Tapper System - Metric



307 SERIES

STANDARD TAPPER FOR METALS AND PLASTICS (SHORT VERSION)

STEEL, CASE HARDENED, ZINC PLATED, YELLOW CHROMATED

Internal Thread	External Thread (mm)	Length (mm)	Part No.		PRICE PER EACH		
					10+	100+	1000+
M3 - 0.5	5	4	3070030.16	*	1.342	1.208	1.117
M3.5 - 0.6	6	5	3070035.16		1.158	1.043	0.964
M4 - 0.7	6.5	6	3070040.16	*	1.271	1.145	1.058
M5 - 0.7	8	7	3070050.16	*	1.401	1.260	1.167
M6 - 1	10	8	3070060.16	*	1.635	1.471	1.360
M8 - 1.25	12	9	3070080.16	*	1.896	1.708	1.578
M10 - 1.5	14	10	3070100.16	*	2.530	2.277	2.107
M12 - 1.5	16	12	3070120.16		3.665	3.300	3.050
M14 - 1.5	18	14	3070140.16		4.812	4.331	4.006
M16 - 2	20	14	3070160.16		6.715	6.042	5.591

Note: External Thread - Special thread with flattened thread root. Tolerances (ISO 2768-m) in accordance with Works Standard 307.

308 SERIES

STANDARD TAPPER FOR METALS AND PLASTICS (LONG VERSION)

STEEL, CASE HARDENED, ZINC PLATED, YELLOW CHROMATED

Internal Thread	External Thread (mm)	Length (mm)	Part No.		PRICE PER EACH		
					10+	100+	1000+
M3 - 0.5	5	6	3080030.16	*	1.386	1.249	1.155
M3.5 - 0.6	6	8	3080035.16		1.247	1.122	1.037
M4 - 0.7	6.5	8	3080040.16	*	1.283	1.155	1.069
M5 - 0.7	8	10	3080050.16	*	1.422	1.280	1.183
M6 - 1	10	12	3080060.16	*	1.945	1.750	1.619
M8 - 1.25	12	14	3080080.16	*	2.181	1.964	1.815
M10 - 1.5	14	18	3080100.16	*	2.823	2.542	2.351
M12 - 1.5	16	22	3080120.16		4.275	3.847	3.559
M14 - 1.5	18	24	3080140.16		4.968	4.471	4.137
M16 - 2	20	24	3080160.16		7.233	6.509	6.020

Note: External Thread - Special thread with flattened thread root. Tolerances (ISO 2768-m) in accordance with Works Standard 308.

309 SERIES

STANDARD TAPPER FOR SOFTWOODS AND PLASTICS

BRASS

Internal Thread	External Thread (mm)	Length (mm)	Part No.		PRICE PER EACH		
					10+	100+	1000+
M2.5 - 0.45	5	6	3090025.80		0.583	0.524	0.485
M3 - 0.5	5.5	6	3090030.80	*	0.603	0.542	0.501
M3.5 - 0.6	6.5	8	3090035.80		0.666	0.599	0.556
M4 - 0.7	7	10	3090040.80	*	0.750	0.676	0.623
M5 - 0.7	9	12	3090050.80	*	0.966	0.870	0.804
M6 - 1	10	14	3090060.80	*	1.664	1.497	1.387
M8 - 1.25	13	20	3090080.80	*	2.284	2.055	1.902
M10 - 1.5	16	23	3090100.80	*	3.999	3.600	3.330
M12 - 1.5	19	26	3090120.80		6.345	5.711	5.281
M16 - 2	24	26	3090160.80		9.086	8.178	7.564

Note: External Thread - Wood thread. Tolerances (ISO 2768-m) in accordance with Works Standard 309.

* Sizes normally available ex stock. Lead time and minimums may apply on all other sizes.
A wider range of sizes and materials available on request. Contact AFS for further information.

The Recoil Tapper System - Inch



UNC / UNF

302 SERIES

STANDARD TAPPER FOR METALS AND PLASTICS (SHORT VERSION)

STEEL, CASE HARDENED, ZINC PLATED YELLOW CHROMATED

Internal Thread	External Thread (mm)	Length (mm)	Part No.	PRICE PER EACH		
				10+	100 +	1000+
#4 - 40 UNC	5	6	3020604.16	0.73	0.66	0.61
#4 - 48 UNF	5	6	3020704.16	0.73	0.66	0.61
#6 - 32 UNC	6	8	3020606.16	0.84	0.75	0.70
#6 - 40 UNF	6	8	3020706.16	0.84	0.75	0.70
#8 - 32 UNC	6.5	8	3020608.16	0.93	0.84	0.78
#8 - 36 UNF	6.5	8	3020708.16	0.93	0.84	0.78
#10 - 24 UNC	8	10	3020610.16	1.05	0.95	0.88
#10 - 32 UNF	8	10	3020710.16	*	0.95	0.88
1/4 - 20 UNC	10	14	3020625.16	*	1.26	1.16
1/4 - 28 UNF	10	14	3020725.16	*	1.26	1.16
5/16 - 18 UNC	12	15	3020631.16	*	1.67	1.54
5/16 - 24 UNF	12	15	3020731.16	*	1.67	1.54
3/8 - 16 UNC	14	18	3020637.16	*	2.49	2.30
3/8 - 24 UNF	14	18	3020737.16	*	2.49	2.30
7/16 - 14 UNC	16	22	3020644.16	*	3.49	3.23
7/16 - 20 UNF	16	22	3020744.16	*	3.49	3.23
1/2 - 13 UNC	18	22	3020650.16	*	4.32	3.99
1/2 - 20 UNF	18	22	3020750.16	*	4.32	3.99
5/8 - 11 UNC	20	22	3020662.16	*	5.74	5.31
5/8 - 18 UNF	20	22	3020762.16	*	5.74	9.22

■ Note: External Thread - Tolerances (ISO 2768-m) in accordance with Works Standard 302.

* Sizes normally available ex stock. Lead time and minimums may apply on all other sizes.

A wider range of sizes and materials available on request. Contact AFS for further information.

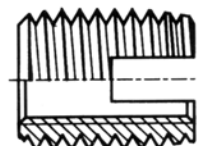

302 Series

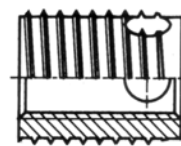

307 Series

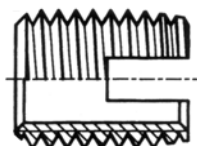

302...40 Series

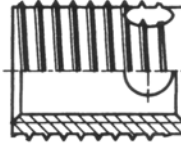

308 Series

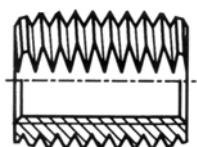

305 Series

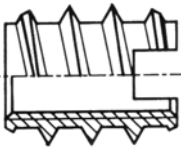

309 Series

Tapper Installation Tools

TAPPER INSTALLATION TOOLS - 620 SERIES DRIVER FOR CONTINUOUS (FLUSH) INSTALLATION			MANDREL	
Internal Thread	Part No.	Price	Part No.	Price
M3	6200030.00	455.68	6200030.70	38.12
M4	6200040.00	455.68	6200040.70	38.12
M5	6200050.00	583.41	6200050.70	38.12
M6	6200060.00	583.41	6200060.70	38.12
M8	6200080.00	583.41	6200080.70	38.12
M10	6200100.00	751.86	6200100.70	62.24
M12	6200120.00	751.86	6200120.70	62.24
M14	6200140.00	1342.06	6200140.70	139.02
M16	6200160.00	1342.06	6200160.70	139.02

TAPPER INSTALLATION TOOLS - 621 SERIES DRIVER FOR CONTINUOUS (DEEP RECEIVING HOLES) INSTALLATION			MANDREL	
Internal Thread	Part No.	Price	Part No.	Price
M3	6210030.00	702.42	6210030.70	134.34
M4	6210040.00	702.42	6210040.70	134.34
M5	6210050.00	872.57	6210050.70	134.34
M6	6210060.00	872.57	6210060.70	134.34
M8	6210080.00	872.57	6210080.70	134.34
M10	6210100.00	1203.91	6210100.70	214.99
M12	6210120.00	1203.91	6210120.70	214.99
M14	6210140.00	2007.65	6210140.70	501.33
M16	6210160.00	2007.65	6210160.70	501.33

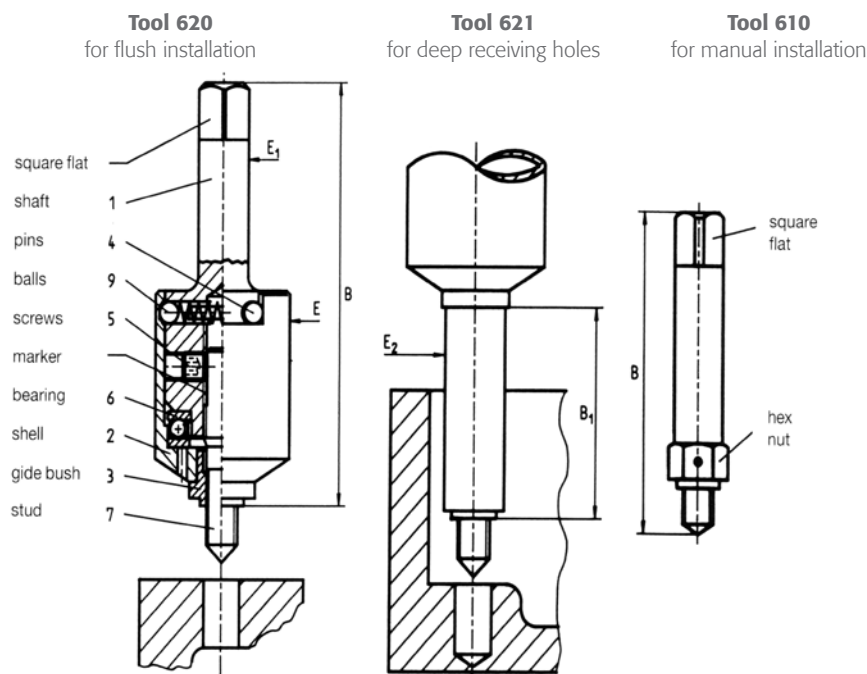

Tapper Installation Tools

Thread Identification and Drill Chart



METRIC

DIAMETER IN INCHES	THREAD SIZE MM	ISO COARSE			OTHER FINE PITCH	ISO FINE			BA				
		PITCH	DRILL SIZE INCH	MM		PITCH	DRILL SIZE INCH	MM	SIZE	DIAMETER INCH	MM	PITCH	DRILL MM
.079	M2	.40		2.1					0	0.236	6.0	1	6.2
.087	M2.2	.45	No.42	2.3					2	0.185	4.7	0.8	4.9
.098	M2.5	.45	No.37	2.6					4	0.142	3.6	0.66	3.8
.118	M3	.5	1/8	3.2					6	0.11	2.8	0.53	2.9
.138	M3.5	.6	No.27	3.7					8	0.86	2.2	0.43	2.3
.157	M4	.7	11/64	4.2					10	0.67	1.7	0.35	1.7
.197	M5	.8	3/64	5.2									
.236	M6	1	1/4	6.3									
.276	M7	1	9/32	7.3									
.315	M8	1.25	21/64	8.3	.75	1	21/64	8.3					
.354	M9	1.25		9.4		1		9.3					
.394	M10	1.5	13/32	10.4	1*	1.25	13/32	10.25					
.433	M11	1.5		11.5	1	1.25		11.25					
.472	M12	1.75	31/64	12.5	1, 1.25*	1.5	31/64	12.25					
.512	M13	1.75		13.5	1.25	1.5		13.25					
.551	M14	2	37/64	14.5	1.25*	1.5	9/16	14.25					
.630	M16	2	21/32	16.5		1.5	21/32	16.5					
.709	M18	2.5	47/64	18.75	1.5*	2	23/32	18.5					
.787	M20	2.5	13/16	20.75	1.5	2	3/16	20.5					
.866	M22	2.5		22.75	1.5	2		22.5					
.945	M24	3		24.75	1.5	2		24.5					

* M10 - 1, M12 - 1.25, M14 - 1.25, M18 - 1.5 - popular sparkplug sizes. Above M24 is available on request.

INCH

DIAMETER		THREAD SIZE	THREADS PER INCH (TPI)						DRILL SIZE					
IN INCHES	MM		UNC	BSW (SAE)	UNF	BSF	BSP*	NPT*	UNC/BSW INCH	MM	UNF/SAE/BSF INCH	MM	BSP/NPT INCH	MM
.86	2.18	#2	56	40	64				3/32	2.3	No.37	2.3		
.99	2.51	#3	48		56				No.36	2.7		2.7		
.112	2.84	#4	40		48				No.31	3.0	No.31	3.0		
.125	3.17	#5, 1/8	40	40	44		28	27	No.29	3.4		3.3	3/8	9.9
.138	3.50	#6	32		40				No.25	3.7	No.26	3.7		
.164	4.16	#8	32		36				11/64	4.4	11/64	4.4		
.190	4.82	#10, 3/16	24		32				13/64	5.1	13/64	5.1		
.187	4.76	#3/16		24		32			13/64	5.0	13/64	5.0		
.216	5.49	#12, 7/32	24		28				15/64	5.6				
.250	6.35	1/4	20	20	28	26	19	18	17/64	6.7	17/64	6.6	33/64	13.5
.312	7.93	5/16	18	18	24	22			21/64	8.3	21/64	8.2		
.375	9.52	3/8	16	16	24	20	19	18	25/64	9.9	25/64	9.8	21/32	17.0
.437	11.11	7/16	14	14	20	18			29/64	11.5	29/64	11.5		
.500	12.70	1/2	13	12	20	16	14	14	17/32	13.0	33/64	13.0	13/16	21.5
.562	14.28	9/16	12	12	18	16			19/32	14.5	37/64	14.5		
.625	15.87	5/8	11	11	18	14			21/32	16.5	41/64	16.25		
.750	19.05	3/4	10	10	16	12	14	14	25/32	19.75	49/64	19.5	1 1/64	27.0
.875	22.22	7/8	9	6	14	11			29/32	23.0	57/64	22.5		
1.00	25.40	1"	8	8	12, 14	10	11	11 1/2	1 1/32	26.0	1 1/64	26.0	1 9/32	33.5
1.125	28.57	1 1/8"	7	7	12	9	11		1 5/32	29.5	1 5/32	29.5		
1.25	31.75	1 1/4"	7	7	12	9	11		1 9/32	33.0	1 9/32	32.5		
1.375	34.92	1 3/8"	6	6	12	8	11		1 13/32	36.0	1 13/32	36.0		
1.50	38.10	1 1/2"	6	6	12	8	11		1 17/32	39.0	1 17/32	39.0		

* Nominal diameters for BSP and NPT are not thread diameters but relate to the inside diameter of the pipe.

Recoil® Bringing versatility to a range of applications.

The range of wire thread inserts by Recoil® are designed to enable you to produce strong threads in softer materials or more evenly distributed thread loads in harder materials. Thread strengthening needs to be fast, reliable and cost effective - decades of engineering experience means Recoil® products carry a global reputation for delivering these OEM essentials.

With a choice of free-running or screw-locking designs, Recoil® offers a broad range of thread insert systems to ensure the best match of product to the application. The standard Recoil® free-running insert provides for easy installation of a female thread,

delivering the necessary “holding power” for most applications. For particularly demanding or extreme high-vibration applications, Recoil® offers a screw-locking design, which provides a superior locking function in the female thread.

Recoil® manufacturing operations are located in Australia, with sales and warehouse facilities strategically placed in North America, Asia and Europe. The European distribution centre is based in Telford, UK.

Proudly Distributed by:

suttontools
world class cutting tools

Sutton Tools Pty Ltd ABN 12 004 175 731

Australia (Head Office) 378 Settlement Road, Thomastown 3074, Victoria Australia
T +61 3 9280 0800 F +61 3 9464 0015

Customer Service 378 Settlement Road, Thomastown 3074, Victoria Australia
T 1800 335 350 F 1800 333 127 E cservice@sutton.com.au

Regrinds Plant 4, 378 Settlement Road, Thomastown 3074, Victoria Australia
T (03) 9466 3315 F (03) 9464 4871 E regrind@sutton.com.au

Special Sales 214 Coleraine Road, Hamilton 3300, Victoria Australia
T 1800 035 010 F 1800 804 084 E specsales@sutton.com.au

Global Offices

Asia Hong Kong • India • Singapore

Australasia Australia (Head Office) • New Zealand

Europe France • Germany • Italy • The Netherlands

www.sutton.com.au

